

bayando 
Design up your Office

www.bayando.eu
info@bayando.eu

BEISPIELE / EXAMPLES

STORAGES / SCHRANK-, REGAL- UND CONTAINER SYSTEME / RENGEMENTS LIGHT



BEISPIELE / EXAMPLES

STORAGES / SCHRANK-, REGAL- UND CONTAINER SYSTEME / RENGEMENTS LIGHT



BEISPIELE / EXAMPLES

Lounge



BEISPIELE / EXAMPLES

LEUCHTEN / LIGHTNING

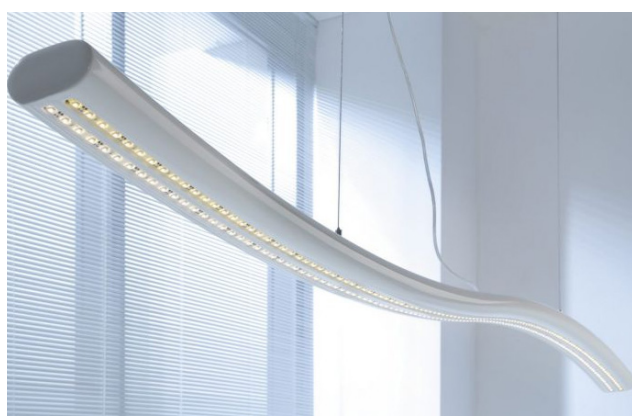

» STORAGES / SCHRANK-, REGAL- UND CONTAINER SYSTEME / RENGEMENTS LIGHT

Top, Bottom panel / Oberplatte, Sockel / Top, Plinthe

							
14-BEECH BÜCHE HÊTRE	31-CANADIAN OAK KANADISCHE EICHE CHENE CANADIEN	34-CHESTNUT WENGE WENGE	39-POLAR BIRCH POLARBIERKE BOULEAU CLAIR	64-COCOA COCOA CACAO	67-WHITE PASTEL WEIß PASTELL BLANC PASTEL	106-LOWLAND NUT NUSSBAUM NOYER	

Front / Front / Façade

							
14-BEECH BÜCHE HÊTRE	31-CANADIAN OAK KANADISCHE EICHE CHENE CANADIEN	34-CHESTNUT WENGE WENGE	39-POLAR BIRCH POLARBIERKE BOULEAU CLAIR	64-COCOA COCOA CACAO	67-WHITE PASTEL WEIß PASTELL BLANC PASTEL	106-LOWLAND NUT NUSSBAUM NOYER	

Body / Korpus / Corps

		
26-ALUMINIUM SATINATO ALUMINIUM SATINATO ALUMINIUM SATINE	67-WHITE PASTEL WEIß PASTELL BLANC PASTEL	





Mobile pedestal / Rollcontainer / Caisson KKT11

	
67-WHITE PASTEL WEIß PASTELL BLANC PASTEL	

Cabinet for photocopier / Kopierer-Schrank / desserte à cases pour photocopieurs S85

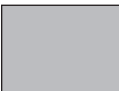

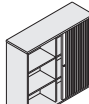
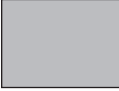

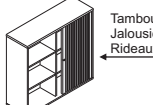
		
26-ALUMINIUM SATINATO ALUMINIUM SATINATO ALUMINIUM SATINE	67-WHITE PASTEL WEIß PASTELL BLANC PASTEL	

Tambour storage / Rollladenschrank / Armoires à rideaux



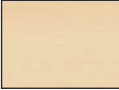
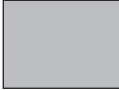
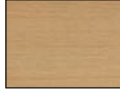
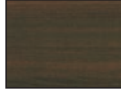
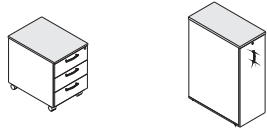

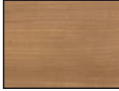

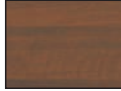
		
26-ALUMINIUM SATINATO ALUMINIUM SATINATO ALUMINIUM SATINE	67-WHITE PASTEL WEIß PASTELL BLANC PASTEL	
		
09-ALUMINIUM ALUMINIUM ALUMINIUM	30-WHITE WEIß BLANC	Tambour Jalousie Rideaux

» PEDESTALS / CONTAINER / CAISSONS



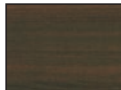
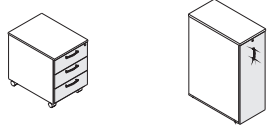

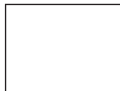

Top, Bottom panel / Oberplatte, Sockel / Top, Plinthe

				
14-BEECH BUCHE HETRE	26-ALUMINUM SATINATO ALUMINIUM SATINATO ALUMINIUM SATINE	31-CANADIAN OAK KANADISCHE EICHE CHENE CANADIEN	34-CHESTNUT WENGE WENGE	
				
39-POLAR BIRCH POLARBIERKE BOULEAU CLAIR	64-COCOA COCOA CACAO	67-WHITE PASTEL WEIß PASTELL BLANC PASTEL	106-LOWLAND NUT NUSSBAUM NOYER	



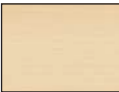
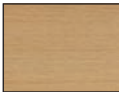
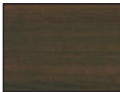

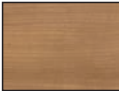
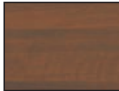
Front / Front / Façade

				
14-BEECH BUCHE HETRE	26-ALUMINUM SATINATO ALUMINIUM SATINATO ALUMINIUM SATINE	31-CANADIAN OAK KANADISCHE EICHE CHENE CANADIEN	34-CHESTNUT WENGE WENGE	
				
39-POLAR BIRCH POLARBIERKE BOULEAU CLAIR	64-COCOA COCOA CACAO	67-WHITE PASTEL WEIß PASTELL BLANC PASTEL	106-LOWLAND NUT NUSSBAUM NOYER	

Body / Korpus / Corps

			I – first group I – erste Gruppe I – premiere groupe de prix
26-ALUMINUM SATINATO ALUMINIUM SATINATO ALUMINIUM SATINE	67-WHITE PASTEL WEIß PASTELL BLANC PASTEL		
			
14-BEECH BUCHE HETRE	31-CANADIAN OAK KANADISCHE EICHE CHENE CANADIEN	34-CHESTNUT WENGE WENGE	
			II – second group II – zweite Gruppe II – deuxième groupe de prix
39-POLAR BIRCH POLARBIERKE BOULEAU CLAIR	64-COCOA COCOA CACAO	106-LOWLAND NUT NUSSBAUM NOYER	

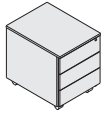
SLD13 / SLD12

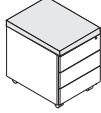
			
67-WHITE PASTEL WEIß PASTELL BLANC PASTEL	08-BLACK SCHWARZ NOIR		
			pedestal pillow Kissen für Container cousin pour les caissons
NX10- GREY GRAU GRIS			

A3R02

		
26-ALUMINUM SATINATO ALUMINIUM SATINATO ALUMINIUM SATINE	67-WHITE PASTEL WEIß PASTELL BLANC PASTEL	

» STORAGES / SCHRANK-, REGAL- UND CONTAINER SYSTEME / RENGEMENTS BASIC

Top, Bottom panel / Oberplatte, Sockel / Top, Plinthe

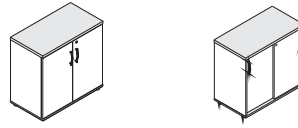
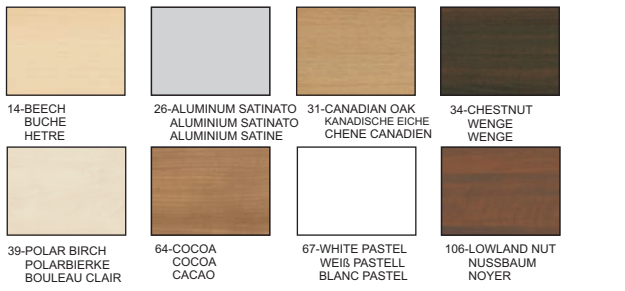

Front / Front / Façade

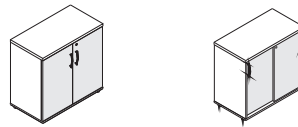

Body / Korpus / Corps

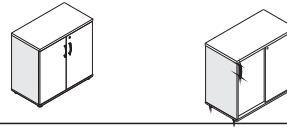
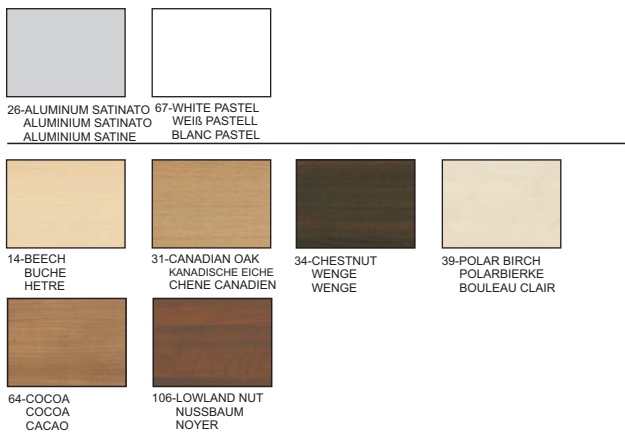



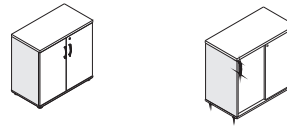

I - first group
I – erste Gruppe
I – première
groupe de prix

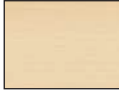
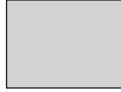
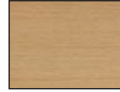
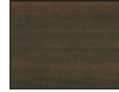

II – second group
II – zweite Gruppe
II – deuxième
groupe de prix

» TAMBOUR STORAGES / JALOUSIESCHRÄNKE / ARMOIRES À RIDEAUX

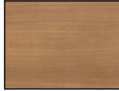
Top, Bottom panel / Oberplatte, Sockel / Top, Plinthe

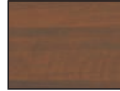
 08-BLACK SCHWARZ NOIR	 14-BEECH BUCHE HETRE	 26-ALUMINIUM SATINATO ALUMINIUM SATINATO ALUMINIUM SATINE	 31-CANADIAN OAK KANADISCHE EICHE CHENE CANADIEN	 34-CHESTNUT WENGE WENGE
 39-POLAR BIRCH POLARBIERKE BOULEAU CLAIR	 64-COCOA COCOA CACAO	 67-WHITE PASTEL WEISS PASTELL BLANC PASTEL	 106-LOWLAND NUT NUSSBAUM NOYER	

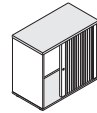

Tambour / Jalousie / Rideaux

 30-WHITE WEISS BLANC	 08-BLACK SCHWARZ NOIR	 09-ALUMINIUM ALUMINIUM ALUMINIUM
---	--	---

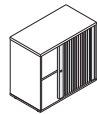

Body / Korpus / Corps

 67-WHITE PASTEL WEISS PASTELL BLANC PASTEL	 08-BLACK SCHWARZ NOIR	 09-ALUMINIUM ALUMINIUM ALUMINIUM
---	--	---

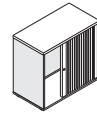

I - first group
I - erste Gruppe
I - première
groupe de prix

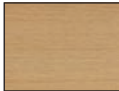
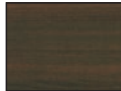
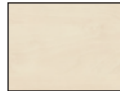
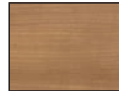
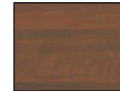

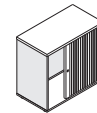



 14-BEECH BUCHE HETRE	 31-CANADIAN OAK KANADISCHE EICHE CHENE CANADIEN	 34-CHESTNUT WENGE WENGE	 39-POLAR BIRCH POLARBIERKE BOULEAU CLAIR	 64-COCOA COCOA CACAO	 106-LOWLAND NUT NUSSBAUM NOYER
--	---	---	--	--	--

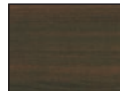
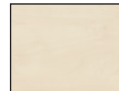

II - second group
II - zweite Gruppe
II - deuxième
groupe de prix

» STORAGES WITH GLASS DOORS / VITRINEN / ARMOIRES AVEC DES FAÇADES EN VERRE

Top, Bottom panel / Oberplatte, Sockel / Top, Plinthe

 14-BEECH BUCHE HETRE	 26-ALUMINIUM SATINATO ALUMINIUM SATINATO ALUMINIUM SATINE	 31-CANADIAN OAK KANADISCHE EICHE CHENE CANADIEN	 34-CHESTNUT WENGE WENGE	 39-POLAR BIRCH POLARBIERKE BOULEAU CLAIR	 64-COCOA COCOA CACAO	 67-WHITE PASTEL WEISS PASTELL BLANC PASTEL	 106-LOWLAND NUT NUSSBAUM NOYER
---	--	--	--	---	---	---	---

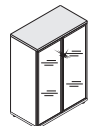

Front / Front / Façade

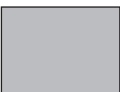
 09-ALUMINIUM ALUMINIUM ALUMINIUM

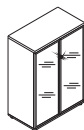



doors with transparent tempered glass and aluminum frame.
Aluminiumrahmen, Klarhartglas.
verre trempé, cadre en aluminium

Body / Korpus / Corps

 26-ALUMINIUM SATINATO ALUMINIUM SATINATO ALUMINIUM SATINE	 67-WHITE PASTEL WEISS PASTELL BLANC PASTEL
--	---

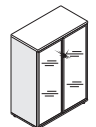
I - first group
I - erste Gruppe
I - première
groupe de prix

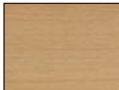
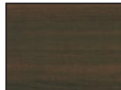
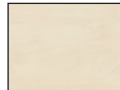
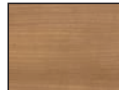
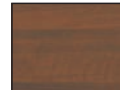

 14-BEECH BUCHE HETRE	 31-CANADIAN OAK KANADISCHE EICHE CHENE CANADIEN	 34-CHESTNUT WENGE WENGE	 39-POLAR BIRCH POLARBIERKE BOULEAU CLAIR	 64-COCOA COCOA CACAO	 106-LOWLAND NUT NUSSBAUM NOYER
---	--	--	---	---	---

II - second group
II - zweite Gruppe
II - deuxième
groupe de prix



» STORAGES WITH METAL SHELVES / SCHRÄNKE UND REGALE MIT METALLFACHBODEN / ARMOIRES AVEC TABLETTES EN METAL

Top, Bottom panel / Oberplatte, Sockel / Top, Plinthe



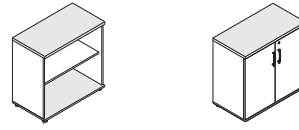

			
14-BEECH BUCHE HETRE	26-ALUMINUM SATINATO ALUMINIUM SATINATO ALUMINIUM SATINE	31-CANADIAN OAK KANADISCHE EICHE CHENE CANADIEN	34-CHESTNUT WENGE WENGE
			
39-POLAR BIRCH POLARBIERKE BOULEAU CLAIR	64-COCOA COCOA CACAO	67-WHITE PASTEL WEISS PASTELL BLANC PASTEL	106-LOWLAND NUT NUSSBAUM NOYER

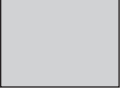

Front / Front / Façade

								
14-BEECH BUCHE HETRE	26-ALUMINUM SATINATO ALUMINIUM SATINATO ALUMINIUM SATINE	31-CANADIAN OAK KANADISCHE EICHE CHENE CANADIEN	34-CHESTNUT WENGE WENGE	39-POLAR BIRCH POLARBIERKE BOULEAU CLAIR	64-COCOA COCOA CACAO	67-WHITE PASTEL WEISS PASTELL BLANC PASTEL	106-LOWLAND NUT NUSSBAUM NOYER	

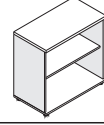
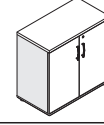
Body / Korpus / Corps

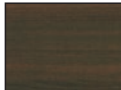
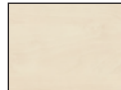
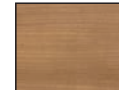
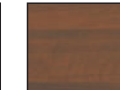
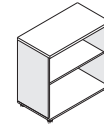
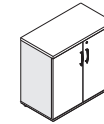
		I - first group / I – erste Gruppe / I – première groupe de prix					
26-ALUMINUM SATINATO ALUMINIUM SATINATO ALUMINIUM SATINE	67-WHITE PASTEL WEISS PASTELL BLANC PASTEL						
						II – second group / II – zweite Gruppe / II – deuxième groupe de prix	
14-BEECH BUCHE HETRE	31-CANADIAN OAK KANADISCHE EICHE CHENE CANADIEN	34-CHESTNUT WENGE WENGE	39-POLAR BIRCH POLARBIERKE BOULEAU CLAIR	64-COCOA COCOA CACAO	106-LOWLAND NUT NUSSBAUM NOYER		

» **STORAGES / SCHRANK-, REGAL- UND CONTAINER SYSTEME / RENGEMENTS BASIC**

ZS01

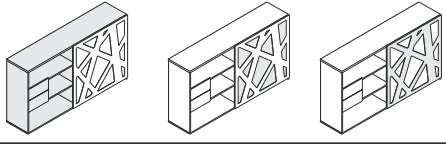
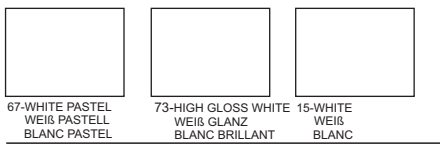

ZS02 | Top, Bottom panel / Oberplatte, Sockel / Top, Plinthe

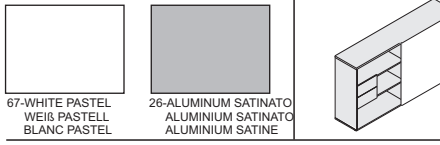

ZS02 | Front HPL / Front HPL / Façade HPL

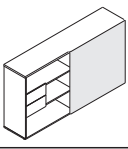

ZS03 | Body / Korpus / Corps



ZS03 | Top, Bottom panel / Oberplatte, Sockel / Top, Plinthe

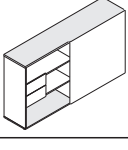
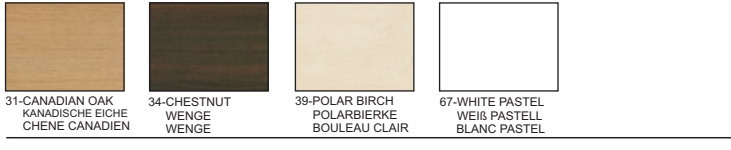



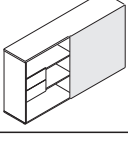

ZS03 | Front / Front / Façade



» STORAGES / SCHRANK-, REGAL- UND CONTAINER SYSTEME / RENGEMENTS GLOSS

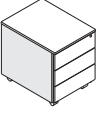
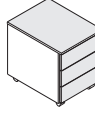

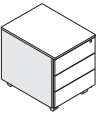
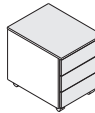
SLD13HT / SLD12HT



Front / Front / Façade

								doors with transparent tempered glass and aluminum frame. Aluminiumrahmen, Klarhartglas. verre trempé, cadre en aluminium
---	---	---	---	---	---	---	---	---

Body, Top, Bottom panel / Korpus, Oberplatte, Sockel / Corps, Top, Plinthe

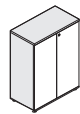
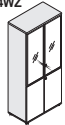
				doors with transparent tempered glass and aluminum frame. Aluminiumrahmen, Klarhartglas. verre trempé, cadre en aluminium
---	---	---	---	---

Glass top / Obeplatte aus Glas / Top en verre

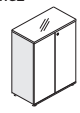
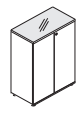
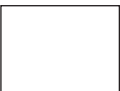
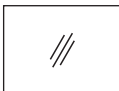
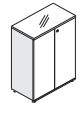
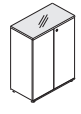
» LOUNGE



ORANGE
ORANGE
ORANGE

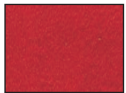

RED
ROT
ROUGE



GREEN
GRÜN
VERT

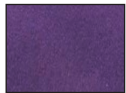

VIOLET
VIOLETT
VIOLET

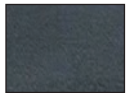

GREY
GRAU
GRIS

PILLOW / KISSEN / COUSSIN

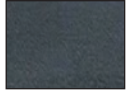
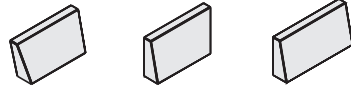

GREY
GRAU
GRIS

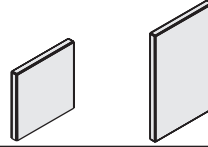

BACK - LOW AND HIGH /
NIEDRIGE UND HOHE
LEHNE /
CLOISON BASSE,
HAUTE

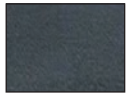

GREY
GRAU
GRIS

SEAT / PUFF / POUF

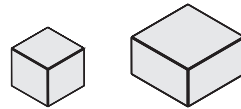

» ELLIPSE



WHITE, GLOSS
WEISS, GLANZ
BLANC, BRILLANT

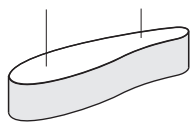

» SUNBEAM



WHITE, GLOSS
WEISS, GLANZ
BLANC, BRILLANT



BLACK, GLOSS
SCHWARZ, GLANZ
NOIR, BRILLANT

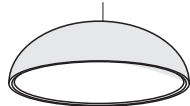

» CANOE



WHITE, GLOSS
WEISS, GLANZ
BLANC, BRILLANT

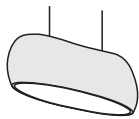

» SNAKE



WHITE, GLOSS
WEISS, GLANZ
BLANC, BRILLANT

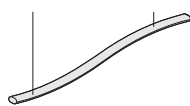

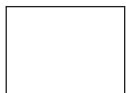

» MULTIMEDIA STATION MS01



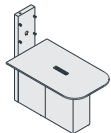







67-WHITE PASTEL
WEISS PASTELL
BLANC PASTEL

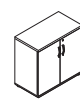
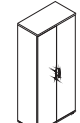

LIGHT - STORAGE / SCHRANKSYSTEME, REGALE UND CONTAINER /RANGEMENTS

	PEDESTALS / CONTAINER / CAISSONS.....	12
	STORAGES / SCHRÄNKE UND REGALE / ARMOIRES ET RANGEMENTS.....	14

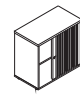
BASIC - STORAGE / SCHRANKSYSTEME, REGALE UND CONTAINER /RANGEMENTS

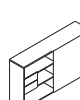
	PEDESTALS / CONTAINER / CAISSONS KDT / KRT	19
	PEDESTALS / CONTAINER / CAISSONS SLD12 / SLD13	23
	CARGO PEDESTALS / CONTAINER CARGO / CAISSONS CARGO KCD80	25
	MOBILE ASSISTANT / MOBILE ASSISTENTEN / MOBILE ASSISTANT A3R02	27
	CABINETS WITH HINGED DOORS / FLÜGELTÜRENSCHRÄNKE / ARMOIRES A PORTES BATTANTES.....	29
	WARDROBES / KLEDERSCHRANK / VESTIAIRES.....	37
	LIDING DOORS STORAGES / SCHRÄNKE MIT SCHIEBETÜREN / ARMOIRES À PORTES COULISSANTES.....	40
	TAMBOUR STORAGES / JALOUSIESCHRÄNKE / ARMOIRES À RIDEAUX.....	42
	STORAGES WITH GLASS DOORS / VITRINEN / ARMOIRES AVEC DES FAÇADES EN VERRE.....	44
	STORAGES WITH METAL SHELVES / SCHRÄNKE UND REGALE MIT METALLFACHBODEN / ARMOIRES AVEC TABLETTES EN METAL.....	46
	STORAGES / SCHRÄNKE / ARMOIRES ZS	49

GLOSS - STORAGE / SCHRANKSYSTEME, REGALE UND CONTAINER /RANGEMENTS

	PEDESTALS / CONTAINER / CAISSONS.....	52
---	---------------------------------------	----

	STORAGES / SCHRÄNKE UND REGALE / ARMOIRES ET RANGEMENTS.....	54
---	---	----

LOUNGE

	LOUNGE.....	57
---	-------------	----

LAMP / LAMPE / LAMPE

	ELLIPSE	66
---	---------------	----

	SUNBEAM.....	68
---	--------------	----

	CANOE	70
---	-------------	----

	SNAKE.....	72
---	------------	----

MULTIMEDIA STATION

	MULTIMEDIA STATION MS01	74
---	--------------------------------------	----



PEDESTAL / CONTAINER / CAISSON

Body / Korps / Corps

MFC / Melaminplatte /
Panneau mélaminé
18mm

Casters / Rollen / Roulettes

- two with locking
- Bremsrollen, 2 Stück
- dont deux équipés de freins
- Ø 50mm,

**MFC Drawer
Schubladen aus Melaminplatte
Tiroirs en mélamine**

- in 26-aluminum satinato, roll runners with 25 kg maximum acceptable load,
- Farbe 26-Aluminium Satinato, Rollenführung (Belastung von 25kg)
- glissières f g âlets, charge jusqu'á 25 kg

Top / Oberplatte / Top

MFC / Melaminplatte /
Panneau mélaminé
18mm

- Central lock with Anti Tilt mechanism (only one drawer may be opened at time), foldable key.
- Zentralverschluss mit Blockierung gegen das gleichzeitige Ausfahren von mehreren Schubladen, Klappschlüssel
- clé gainée articulée, serrure centralisée, assure la fermeture de l'ensemble des tiroirs

Front / Front / Façade

MFC / Melaminplatte /
Panneau mélaminé
18mm

Top / Oberplatte / Top

MFC / Melaminplatte /
Panneau mélaminé
28mm

**Leveling feet
Bodenausgleich
Vérins de réglage**

20mm

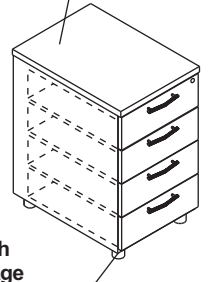
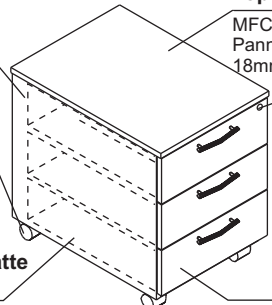

Pedestals with filing drawers equipped with counterweight to ensure the stability of the pedestals
Im Container mit Hängeregisterschublade wurde Gegengewicht zugegeben, um die Stabilität des Containers zu verbessern
Caissons avec tiroir DS équipés d'un contrepoids, afin d'assurer la stabilité de caissons

Body / Korps / Corps

MFC / Melaminplatte /
Panneau mélaminé
18mm

Casters / Rollen / Roulettes

- two with locking
- Bremsrollen, 2 Stück
- dont deux équipés de freins
- Ø 50mm,

**MFC Drawer
Schubladen aus Melaminplatte
Tiroirs en mélamine**

- in 26-aluminum satinato, roll runners with 25 kg maximum acceptable load,
- Farbe 26-Aluminium Satinato, Rollenführung (Belastung von 25kg)
- glissières f g âlets, charge jusqu'á 25 kg

Top / Oberplatte / Top

MFC / Melaminplatte /
Panneau mélaminé
18mm

- Central lock with Anti Tilt mechanism (only one drawer may be opened at time), foldable key.
- Zentralverschluss mit Blockierung gegen das gleichzeitige Ausfahren von mehreren Schubladen, Klappschlüssel
- clé gainée articulée, serrure centralisée, assure la fermeture de l'ensemble des tiroirs

Front / Front / Façade

MFC / Melaminplatte /
Panneau mélaminé
18mm

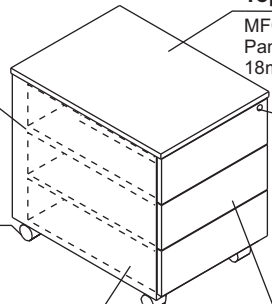

FINISHES / FARBEN / FINITIONS

Top, Bottom panel / Oberplatte, Sockel / Top, Plinthe

14-BEECH BUCHE HETRE	31-CANADIAN OAK KANADISCHE EICHE CHENE CANADIEN	34-CHESTNUT WENGE WENGE	39-POLAR BIRCH POLARBIERKE BOULEAU CLAIR	64-COCOA COCOA CACAO	67-WHITE PASTEL WEIß PASTELL BLANC PASTEL	106-LOWLAND NUT NUSSBAUM NOYER	
----------------------------	---	-------------------------------	--	----------------------------	---	--------------------------------------	--

Front / Front / Façade



14-BEECH BUCHE HETRE	31-CANADIAN OAK KANADISCHE EICHE CHENE CANADIEN	34-CHESTNUT WENGE WENGE	39-POLAR BIRCH POLARBIERKE BOULEAU CLAIR	64-COCOA COCOA CACAO	67-WHITE PASTEL WEIß PASTELL BLANC PASTEL	106-LOWLAND NUT NUSSBAUM NOYER	
----------------------------	---	-------------------------------	--	----------------------------	---	--------------------------------------	--

Body / Korpus / Corps





26-ALUMINIUM SATINATO ALUMINIUM SATINATO ALUMINIUM SATINE	67-WHITE PASTEL WEIß PASTELL BLANC PASTEL	
---	---	--

Mobile pedestal / Rollcontainer / Caisson KKT11

67-WHITE PASTEL WEIß PASTELL BLANC PASTEL	
---	--

PRODUCT ILLUSTRATION / PRODUKTANSICHT UND SKIZZE / VUE DE PRODUIT	DIMENSIONS / ABMESSUNGEN [mm]			INDEX SYMBOL	PRICE EUR				ECO	COMMENTS / BEMERKUNGEN / REMARQUES
	WIDTH / BREITE / LARGEUR	DEPTH / TIEFE / PROFONDEUR	HEIGHT / HÖHE / HAUTEUR			kg	m3	pcs	EUR	

PEDESTALS / CONTAINER / CAISSONS

	402	600	586	KKT12		24.0	0.141	1	2.664	
	402	600	586	KKT13		30.0	0.142	1	3.330	
	402	600	740	KKT64		35.6	0.195	1	3.952	
	402	800	740	KKT74		35.0	0.258	1	3.885	

MOBILE PEDESTAL / ROLLCONTAINER / CAISSON

	416	600	586	KKT11		30.0	0.153	1	3.330	no handles, only in white / halterlos, ausschließlich in Weiß Pastell / sans poignées, seulement en blanc
--	-----	-----	-----	--------------	--	------	-------	---	-------	--

DESCRIPTION / LEGENDE / LÉGENDE:

 net weight / Nettogewicht / poids net

 volume / Volumen / le volume

 number of packages / Stückzahl der Pakete / nombre de colis



STORAGES / SCHRÄNKE / RANGEMENTS

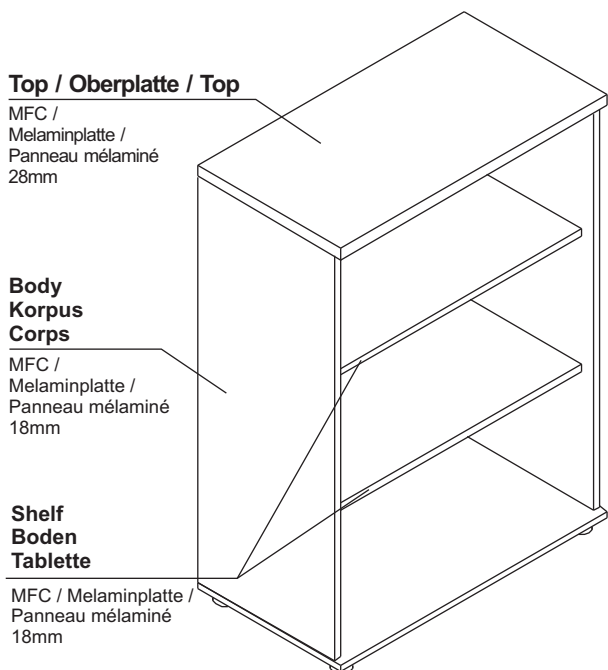
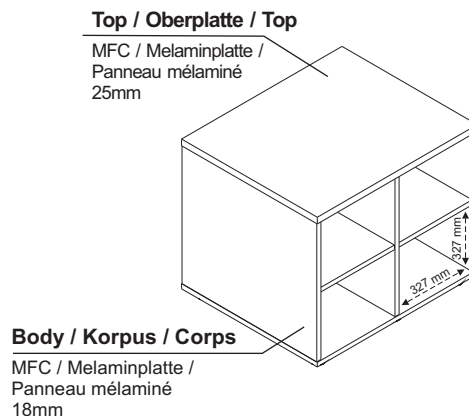
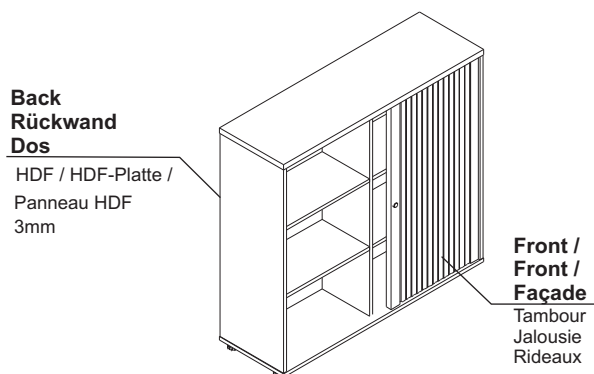
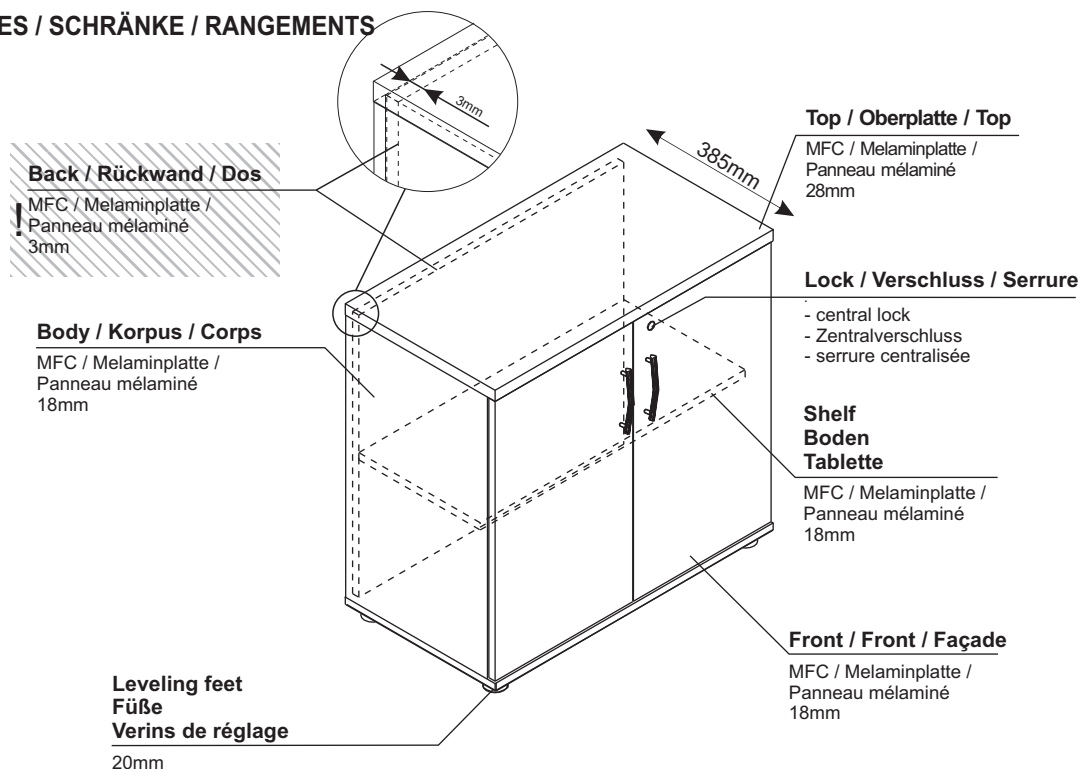



FINISHES / FARBEN / FINITIONS

Top, Bottom panel / Oberplatte, Sockel / Top, Plinthe

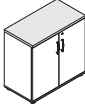
14-BEECH BUCHE HETRE	31-CANADIAN OAK KANADISCHE EICHE CHENE CANADIEN	34-CHESTNUT WENGE WENGE	39-POLAR BIRCH POLARBIERKE BOULEAU CLAIR	64-COCOA COCOA CACAO	67-WHITE PASTEL WEIß PASTELL BLANC PASTEL	106-LOWLAND NUT NUSSBAUM NOYER	
----------------------------	---	-------------------------------	--	----------------------------	---	--------------------------------------	---

Front / Front / Façade

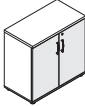
14-BEECH BUCHE HETRE	31-CANADIAN OAK KANADISCHE EICHE CHENE CANADIEN	34-CHESTNUT WENGE WENGE	39-POLAR BIRCH POLARBIERKE BOULEAU CLAIR	64-COCOA COCOA CACAO	67-WHITE PASTEL WEIß PASTELL BLANC PASTEL	106-LOWLAND NUT NUSSBAUM NOYER	
----------------------------	---	-------------------------------	--	----------------------------	---	--------------------------------------	---

Body / Korpus / Corps



26-ALUMINIUM SATINATO ALUMINIUM SATINATO ALUMINIUM SATINE	67-WHITE PASTEL WEIß PASTELL BLANC PASTEL	
---	---	---

Cabinet for photocopier / Kopierer-Schrank / desserte à cases pour photocopieurs S85

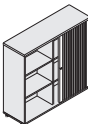
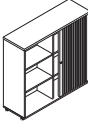

26-ALUMINIUM SATINATO ALUMINIUM SATINATO ALUMINIUM SATINE	67-WHITE PASTEL WEIß PASTELL BLANC PASTEL	
---	---	---

Tambour storage / Rollladenschrank / Armoires à rideaux



26-ALUMINIUM SATINATO ALUMINIUM SATINATO ALUMINIUM SATINE	67-WHITE PASTEL WEIß PASTELL BLANC PASTEL	
09-ALUMINIUM ALUMINIUM ALUMINIUM	30-WHITE WEIß BLANC	 Tambour Jalousie Rideaux

PRODUCT ILLUSTRATION / PRODUKTANSICHT UND SKIZZE / VUE DE PRODUIT	DIMENSIONS / ABMESSUNGEN [mm]			INDEX SYMBOL	PRICE EUR				ECO	COMMENTS / BEMERKUNGEN / REMARQUES
	WIDTH / BREITE / LARGEUR	DEPTH / TIEFE / PROFONDEUR	HEIGHT / HÖHE / HAUTEUR			kg	m3	pcs	EUR	



2H STORAGE / SCHRÄNKE UND REGALE 2OH / ARMOIRES ET RANGEMENTS 2OH

	801	385	777	K2104		26.0	0.069	3	2.886	
	801	385	777	K2504		19.0	0.049	2	2.109	

2H STACK-ON STORAGE / ANSATZSTÜCKE 2OH / REHAUSSES 2OH

	801	385	750	K1104		26.0	0.069	3	2.886	
	801	385	750	K1504		19.0	0.049	2	2.109	

3H STORAGE / SCHRÄNKE UND REGALE 3OH / ARMOIRES ET RANGEMENTS 3 OH



	801	385	1129	K3104		36.3	0.085	3	4.029	
	801	385	1129	K3404		32.0	0.078	3	3.552	
	801	385	1129	K3504		25.0	0.059	2	2.775	

DESCRIPTION / LEGENDE / LÉGENDE:





 net weight / Nettogewicht / poids net

 volume / Volumen / le volume

 number of packages / Stückzahl der Pakete / nombre de colis

PRODUCT ILLUSTRATION / PRODUKTANSICHT UND SKIZZE / VUE DE PRODUIT	DIMENSIONS / ABMESSUNGEN [mm]			INDEX SYMBOL	PRICE EUR				ECO	COMMENTS / BEMERKUNGEN / REMARQUES
	WIDTH / BREITE / LARGEUR	DEPTH / TIEFE / PROFONDEUR	HEIGHT / HÖHE / HAUTEUR			kg	m3	pcs	EUR	

5H STORAGE / SCHRÄNKE UND REGALE 50H / ARMOIRES ET RANGEMENTS 50H

	801	385	1833	K5104		58.7	0.142	3	6.510	
	801	385	1833	K5304		51.3	0.126	3	5.694	
	801	385	1833	K5404		47.0	0.120	3	5.217	
	801	385	1833	K5504		40.0	0.100	2	4.440	

WARDROBES / KLEIDERSCHRANK / VESTIAIRES

	801	385	1833	K5204		50.0	0.116	3	5.550	wardrobe with slide out hanger / Kleiderschrank mit ausfahbarem Kleiderbügel / armoire avec penderie retractable
--	-----	-----	------	--------------	--	------	-------	---	-------	---

TAMBOUR STORAGE / ROLLADENSCHRANK / ARMOIRES À RIDEAUX

	1200	385	1129	K3Z06		64.0	0.600	1	7.104	all in 26-aluminum satinato or 67-white pastel / ganz in Farbe 26 - aluminium satinati oder 67 - pastellweiß / tout en couleur 26 aluminium satinato ou 67 blanc pastel
---	------	-----	------	--------------	--	------	-------	---	-------	--

CABINET FOR PHOTOCOPIER / KOPIERER-SCHRANK / DESSERTTE À CASES POUR PHOTOCOPIEURS



	710	600	600	S85		32.0	0.066	1	3.552	under printer storage, all in 26-aluminum satinato or 67-white pastel / Kopierer-Schrank, ganz in Farbe 26 - aluminium satinati oder 67 - pastellweiß / rangement pour mettre une photocopieuse dessus, tout en couleur 26 ALUMINIUM
---	-----	-----	-----	------------	--	------	-------	---	-------	--

DESCRIPTION / LEGENDE / LÉGENDE:



 net weight / Nettogewicht / poids net

 volume / Volumen / le volume

 number of packages / Stückzahl der Pakete / nombre de colis

PRODUCT ILLUSTRATION / PRODUKTANSICHT UND SKIZZE / VUE DE PRODUIT	DIMENSIONS / ABMESSUNGEN [mm]			INDEX SYMBOL	PRICE EUR				ECO	COMMENTS / BEMERKUNGEN / REMARQUES
	WIDTH / BREITE / LARGEUR	DEPTH / TIEFE / PROFONDEUR	HEIGHT / HÖHE / HAUTEUR			kg	m3	pcs	EUR	

ADDITIONAL ELEMENTS FOR STORAGE / ERGÄNZENDE BAUTEILE FÜR SCHRÄNKE / MEUBLES ET ÉLÉMENTS SUPPLÉMENTAIRES

	800	5	1050	KS310		12.0	0.034	1	1.332	glass doors (2pcs) 3h, transparent tempered glass / Glastüren (2 Stck.) 3OH, durchsichtiges Sicherheitsglas / porte vitrée (2pièces) 3OH, verre trempé transparent
	800	20	1050	KS300		10.3	0.037	1	1.143	- set of glass doors (2PCS) 3H with aluminum frame, frosted glass / Glastür (2 Stck.) 3OH, mit Aluminiumrahmen, gehärtetes Milchglas / porte vitrée 2 (pcs) 3OH avec un cadre en aluminium, verre trempé satiné

DESCRIPTION / LEGENDE / LÉGENDE:

 net weight / Nettogewicht / poids net

 volume / Volumen / le volume

 number of packages / Stückzahl der Pakete / nombre de colis



PEDESTAL KDT / CONTAINER KDT / CAISSON KDT

Top / Oberplatte / Top

MFC / Melaminplatte /
Panneau mélaminé
18mm

Body / Korps / Corps

MFC / Melaminplatte /
Panneau mélaminé
18mm

**Metal drawers
Metallschubladen
Tiroirs en metal**

- self closing system as an option
- Roll runners with 25 kg maximum acceptable load . Extraction 80%.
- Leises Selbstschließsystem als Option
- Rollenführungsschiene mit einer Belastung von max. 25kg. 80% Auszug.
- Glissieres a galets, fermeture silencieuse en option, Glissieres a billes en option.Charge jusqu 'a 25 kg. Extraction 80%.
- Depth / Tiefe / Profondeur - 500mm

Front / Front / Façade

MFC / Melaminplatte /
Panneau mélaminé
18mm

- Central lock with Anti Tilt mechanism (only one drawer may be opened at time), foldable key.
- Zentralverschluss mit Blockierung gegen das gleichzeitige Ausfahren von mehreren Schubladen, Klappschlüssel
- clé gainée articulée, serrure centralisée, assure la fermeture de l'ensemble des tiroirs

Extraction 80%
80% Auszug
Extraction 80%

Casters / Rollen / Roulettes

- two with locking
- Bremsrollen, 2 Stück
- dont deux équipés de freins
- Ø 50mm,

**Suspension file drawer
Aktenschublade
Tiroir vec DS.**

Extraction 100%
100% Auszug
Extraction 100%

PEDESTAL KRT / CONTAINER KRT / CAISSON KRT

Top / Oberplatte / Top

MFC / Melaminplatte /
Panneau mélaminé
18mm

Body / Korps / Corps

MFC / Melaminplatte /
Panneau mélaminé
18mm

**Metal drawers
Metallschubladen
Tiroirs en metal**

- self closing system as an option
- Roll runners with 25 kg maximum acceptable load . Extraction 80%.
- Leises Selbstschließsystem als Option
- Rollenführungsschiene mit einer Belastung von max. 25kg. 80% Auszug.
- Glissieres a galets, fermeture silencieuse en option, Glissieres a billes en option.Charge jusqu 'a 25 kg. Extraction 80%.
- Depth / Tiefe / Profondeur - 500mm

**Only in KRT pedestals
Nur bei KRT Containers
Seulement dans caissons KRT**

Separate pencil drawer
Material separat
iroir plumier séparé

Front / Front / Façade

MFC / Melaminplatte /
Panneau mélaminé
18mm

Casters / Rollen / Roulettes

- two with locking
- Bremsrollen, 2 Stück
- dont deux équipés de freins
- Ø 50mm,

Extraction 80%
80% Auszug
Extraction 80%

**Suspension file drawer
Aktenschublade
Tiroir vec DS.**

Extraction 100%
100% Auszug
Extraction 100%

**DESK HEIGHT PEDESTAL KDT
CONTAINER KDT
CAISSON HAUTEUR BUREAU KDT**

Top / Oberplatte / Top

MFC / Melaminplatte /
Panneau mélaminé
18mm

**Leveling feet
Bodenausgleich
Vérins de réglage**
20mm

**Metal drawers
Metallschubladen
Tiroirs en metal**

- Depth / Tiefe / Profondeur - 500mm

**DESK HEIGHT PEDESTAL KRT
CONTAINER KRT
CAISSON HAUTEUR BUREAU KRT**

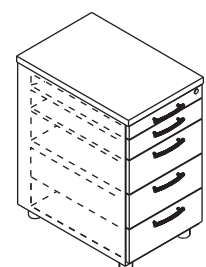
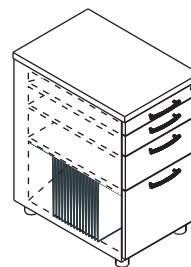
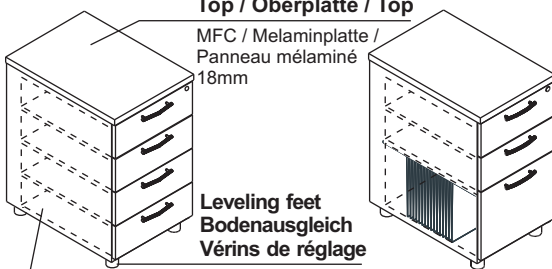



FINISHES / FARBEN / FINITIONS



Top, Bottom panel / Oberplatte, Sockel / Top, Plinthe



14-BEECH BUCHE HETRE	26-ALUMINUM SATINATO ALUMINIUM SATINATO ALUMINIUM SATINE	31-CANADIAN OAK KANADISCHE EICHE CHENE CANADIEN	34-CHESTNUT WENGE WENGE	39-POLAR BIRCH POLARBIERKE BOULEAU CLAIR	64-COCOA COCOA CACAO	67-WHITE PASTEL WEIß PASTELL BLANC PASTEL	106-LOWLAND NUT NUSSBAUM NOYER	
----------------------------	--	---	-------------------------------	--	----------------------------	---	--------------------------------------	---

Front / Front / Façade







14-BEECH BUCHE HETRE	26-ALUMINUM SATINATO ALUMINIUM SATINATO ALUMINIUM SATINE	31-CANADIAN OAK KANADISCHE EICHE CHENE CANADIEN	34-CHESTNUT WENGE WENGE	39-POLAR BIRCH POLARBIERKE BOULEAU CLAIR	64-COCOA COCOA CACAO	67-WHITE PASTEL WEIß PASTELL BLANC PASTEL	106-LOWLAND NUT NUSSBAUM NOYER	
----------------------------	--	---	-------------------------------	--	----------------------------	---	--------------------------------------	---

Body / Korpus / Corps



26-ALUMINUM SATINATO ALUMINIUM SATINATO ALUMINIUM SATINE	67-WHITE PASTEL WEIß PASTELL BLANC PASTEL	I - first group I - erste Gruppe I - première groupe de prix						
14-BEECH BUCHE HETRE	31-CANADIAN OAK KANADISCHE EICHE CHENE CANADIEN	34-CHESTNUT WENGE WENGE	39-POLAR BIRCH POLARBIERKE BOULEAU CLAIR	64-COCOA COCOA CACAO	106-LOWLAND NUT NUSSBAUM NOYER	II - second group II - zweite Gruppe II - deuxième groupe de prix		



PRODUCT ILLUSTRATION / PRODUKTANSICHT UND SKIZZE / VUE DE PRODUIT	DIMENSIONS / ABMESSUNGEN [mm]			INDEX SYMBOL	PRICE EUR				ECO	COMMENTS / BEMERKUNGEN / REMARQUES
	WIDTH / BREITE / LARGEUR	DEPTH / TIEFE / PROFONDEUR	HEIGHT / HÖHE / HAUTEUR			kg	m3	pcs	EUR	

KDT PEDESTALS / KDT-CONTAINER / CAISSONS KDT

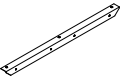
	402	600	586	KDT12		23.0	0.151	1	2.553	file drawer / Schublade für file drawer / tiroir pour dossier suspendu
	402	600	586	KDT13		23.0	0.151	1	2.553	
	402	600	740	KDT63		28.0	0.211	1	3.108	file drawer / Schublade für file drawer / tiroir pour dossier suspendu
	402	600	740	KDT64		28.0	0.193	1	3.108	
	402	800	740	KDT73		31.0	0.255	1	3.441	file drawer / Schublade für file drawer / tiroir pour dossier suspendu
	402	800	740	KDT74		31.0	0.255	1	3.441	

CONNECTING ELEMENTS / BEFESTIGUNGSELEMENTE / ÉLÉMENTS DE FIXATION

	620	30	30	E31		0.6	0.001	1	0.076	angle bracket for 800mm edges / Randprofil 800 mm / équerre pour l'élément de 800 mm
	450	30	30	E32		0.5	0.000	1	0.055	angle bracket for 600mm edges / Randprofil 600 mm / équerre pour l'élément de 600 mm
	330	30	30	E37		1.5	0.000	1	0.184	angle bracket / Randprofil / équerre



	KDT12	KDT13	KDT63	KDT64	KDT73	KDT74							
										0.0	0.0000	0	
										1.0	0.0010	1	
										1.0	0.0010	1	

DESCRIPTION / LEGENDE / LÉGENDE:







 net weight / Nettogewicht / poids net

 volume / Volumen / le volume

 number of packages / Stückzahl der Pakete / nombre de colis

PRODUCT ILLUSTRATION / PRODUKTANSICHT UND SKIZZE / VUE DE PRODUIT	DIMENSIONS / ABMESSUNGEN [mm]			INDEX SYMBOL	PRICE EUR				ECO EUR	COMMENTS / BEMERKUNGEN / REMARQUES
	WIDTH / BREITE / LARGEUR	DEPTH / TIEFE / PROFONDEUR	HEIGHT / HÖHE / HAUTEUR			kg	m3	pcs		



KRT PEDESTALS / CONTAINER KRT / CAISSONS KRT

	402	600	586	KRT12		23.0	0.151	1	2.553	file drawer / Schublade für file drawer / tiroir pour dossier suspendu
	402	600	586	KRT13		23.0	0.151	1	2.553	
	402	600	740	KRT63		28.0	0.211	1	3.108	file drawer / Schublade für file drawer / tiroir pour dossier suspendu
	402	600	740	KRT64		28.0	0.211	1	3.108	
	402	800	740	KRT73		31.0	0.255	1	3.441	file drawer / Schublade für file drawer / tiroir pour dossier suspendu
	402	800	740	KRT74		31.0	0.255	1	3.441	

PEDESTAL PILLOW / KISSEN FÜR CONTAINER / PANNEAU TISSU

	416	600	40	SKP13		2.0	0.015	1	0.222	pedestal pillow for sld12, sld13, sld12ht, sld13ht / Kissen für Container: SLD12, SLD13, SLD12HT, SLD13HT / coussin pour les caissons: SLD12, SLD13, SLD12HT, SLD13HT
---	-----	-----	----	--------------	--	-----	-------	---	-------	---

ADDITIONAL CHARGE / AUFPREIS FÜR SONDERAUSSTATTUNG / PLUS VALUE

FEATURE / EIGENSCHAFT / ATTRIBUT	PRODUCT / SYMBOL / PRODUITS										COMMENTS / BEMERKUNGEN / REMARQUES
	KRT12	KRT13	KRT63	KRT64	KRT73	KRT74		kg	m3	pcs	
II PRICE GROUP / II PREISGRUPPE / II GROUPE DE PRIX.								0.0	0.0000	0	
self closing system / Selbtschließsystem / fermeture silencieuse								1.0	0.0010	1	
Ball runners / Kugelführungen / Glissières à billes								1.0	0.0010	1	

DESCRIPTION / LEGENDE / LÉGENDE:

 net weight / Nettogewicht / poids net

 volume / Volumen / le volume

 number of packages / Stückzahl der Pakete / nombre de colis



**PEDESTAL / CONTAINER / CAISSON
 SLD13 / SLD12**

Top / Oberplatte / Top

MFC / Melaminplatte /
 Panneau mélaminé
 18mm

- central lock with antitilt mechanism (only one
 drawer may be opened at time), foldable key.
 - Zentralverschluss mit Blockierung gegen das gleichzeitige
 Ausfahren von mehreren Schubladen, Klappschlüssel
 - clé gainée articulée, serrure centralisée, assure la fermeture
 de l'ensemble des tiroirs

Body / Korpus / Corps

MFC / Melaminplatte /
 Panneau mélaminé
 18mm

**Metal drawers
 Metallschubladen
 Tiroirs en metal**

- self closing system as an option
 roll runners with 25 kg maximum
 acceptable load . Extraction 80%.
 - Leises Selbstschließsystem als Option
 Rollenführungsschiene mit einer Belastung
 von max. 25kg. 80% Auszug.
 - Glissieres a galets, fermeture silencieuse en option,
 Glissieres a billes en option. Charge jusqu 'a 25 kg.
 Extraction 80%.

Front / Front / Façade

MFC / Melaminplatte /
 Panneau mélaminé

Extraction 80%
 80% Auszug
 Extraction 80%

Casters/ Rollen / Roulettes

- two of them with brakes
 - Bremsrollen vorne
 - dont deux équipés de freins
 ø50mm

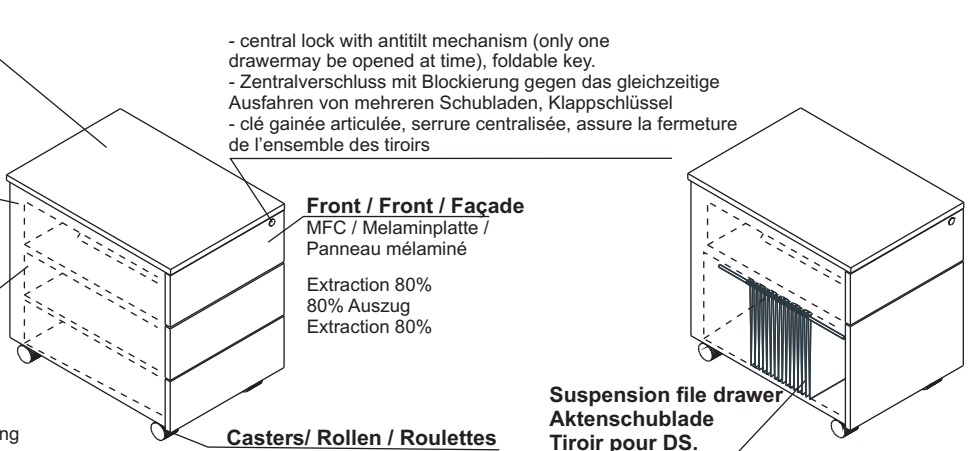

**Suspension file drawer
 Aktenschublade
 Tiroir pour DS.**

Extraction 100%
 100% Auszug
 Extraction 100%



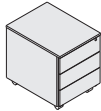
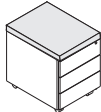

FINISHES / FARBEN / FINITIONS



<p>67-WHITE PASTEL WEIß PASTELL BLANC PASTEL</p> <p>08-BLACK SCHWARZ NOIR</p>	
<p>NX10- GREY GRAU GRIS</p>	 <p>pedestal pillow Kissen für Container coussin pour les caissons</p>

PRODUCT ILLUSTRATION / PRODUKTANSICHT UND SKIZZE / VUE DE PRODUIT	DIMENSIONS / ABMESSUNGEN [mm]			INDEX SYMBOL	PRICE EUR				ECO	COMMENTS / BEMERKUNGEN / REMARQUES
	WIDTH / BREITE / LARGEUR	DEPTH / TIEFE / PROFONDEUR	HEIGHT / HÖHE / HAUTEUR			kg	m3	pcs	EUR	

MOBILE PEDESTALS / ROLLCONTAINER / CAISSON

	416	600	586	SLD12		23.0	0.158	1	2.553	
	416	600	586	SLD13		30.0	0.158	1	3.330	

ADDITIONAL CHARGE / AUFPREIS FÜR SONDERAUSSTATTUNG / PLUS VALUE

													
	SLD12	SLD13											
										1.0	0.0010	1	
										1.0	0.0010	1	

DESCRIPTION / LEGENDE / LÉGENDE:

 net weight / Nettogewicht / poids net

 volume / Volumen / le volume

 number of packages / Stückzahl der Pakete / nombre de colis



PEDESTAL / CONTAINER / CAISSON KCD80

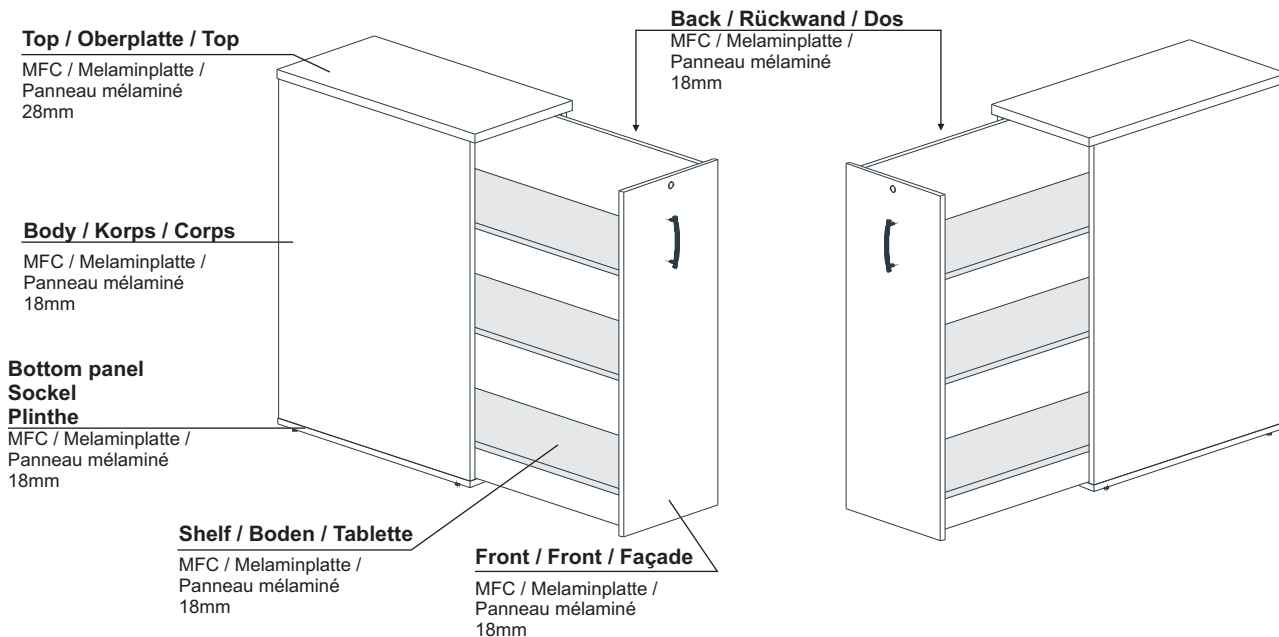

FINISHES / FARBEN / FINITIONS

Top, Bottom panel / Oberplatte, Sockel / Top, Plinthe



14-BEECH BUCHE HETRE	26-ALUMINUM SATINATO ALUMINIUM SATINATO ALUMINIUM SATINE	31-CANADIAN OAK KANADISCHE EICHE CHENE CANADIEN	34-CHESTNUT WENGE WENGE	39-POLAR BIRCH POLARBIERKE BOULEAU CLAIR	64-COCOA COCOA CACAO	67-WHITE PASTEL WEISS PASTELL BLANC PASTEL	106-LOWLAND NUT NUSSBAUM NOYER	
----------------------------	--	---	-------------------------------	--	----------------------------	--	--------------------------------------	--

Front / Front / Façade

14-BEECH BUCHE HETRE	26-ALUMINUM SATINATO ALUMINIUM SATINATO ALUMINIUM SATINE	31-CANADIAN OAK KANADISCHE EICHE CHENE CANADIEN	34-CHESTNUT WENGE WENGE	39-POLAR BIRCH POLARBIERKE BOULEAU CLAIR	64-COCOA COCOA CACAO	67-WHITE PASTEL WEISS PASTELL BLANC PASTEL	106-LOWLAND NUT NUSSBAUM NOYER	
----------------------------	--	---	-------------------------------	--	----------------------------	--	--------------------------------------	--

Body / Korpus / Corps



26-ALUMINUM SATINATO ALUMINIUM SATINATO ALUMINIUM SATINE	67-WHITE PASTEL WEISS PASTELL BLANC PASTEL	I - first group I – erste Gruppe I – première groupe de prix						
14-BEECH BUCHE HETRE	31-CANADIAN OAK KANADISCHE EICHE CHENE CANADIEN	34-CHESTNUT WENGE WENGE	39-POLAR BIRCH POLARBIERKE BOULEAU CLAIR	64-COCOA COCOA CACAO	106-LOWLAND NUT NUSSBAUM NOYER	II – second group II – zweite Gruppe II – deuxième groupe de prix		

PRODUCT ILLUSTRATION / PRODUKTANSICHT UND SKIZZE / VUE DE PRODUIT	DIMENSIONS / ABMESSUNGEN [mm]			INDEX SYMBOL	PRICE EUR				ECO	COMMENTS / BEMERKUNGEN / REMARQUES
	WIDTH / BREITE / LARGEUR	DEPTH / TIEFE / PROFONDEUR	HEIGHT / HÖHE / HAUTEUR			kg	m3	pcs	EUR	

CARGO PEDESTALS / CONTAINER CARGO / CAISSONS CARGO

	402	800	1100	KCD80		65.0	0.138	2	7.215	universal left or right / universal, links oder rechts / universel : gauche ou droit
---	-----	-----	------	--------------	--	------	-------	---	-------	--

ADDITIONAL CHARGE / AUFPREIS FÜR SONDERAUSSTATTUNG / PLUS VALUE

													
	KCD80												
										0.0	0.0000	0	

DESCRIPTION / LEGENDE / LÉGENDE:

 net weight / Nettogewicht / poids net

 volume / Volumen / le volume

 number of packages / Stückzahl der Pakete / nombre de colis



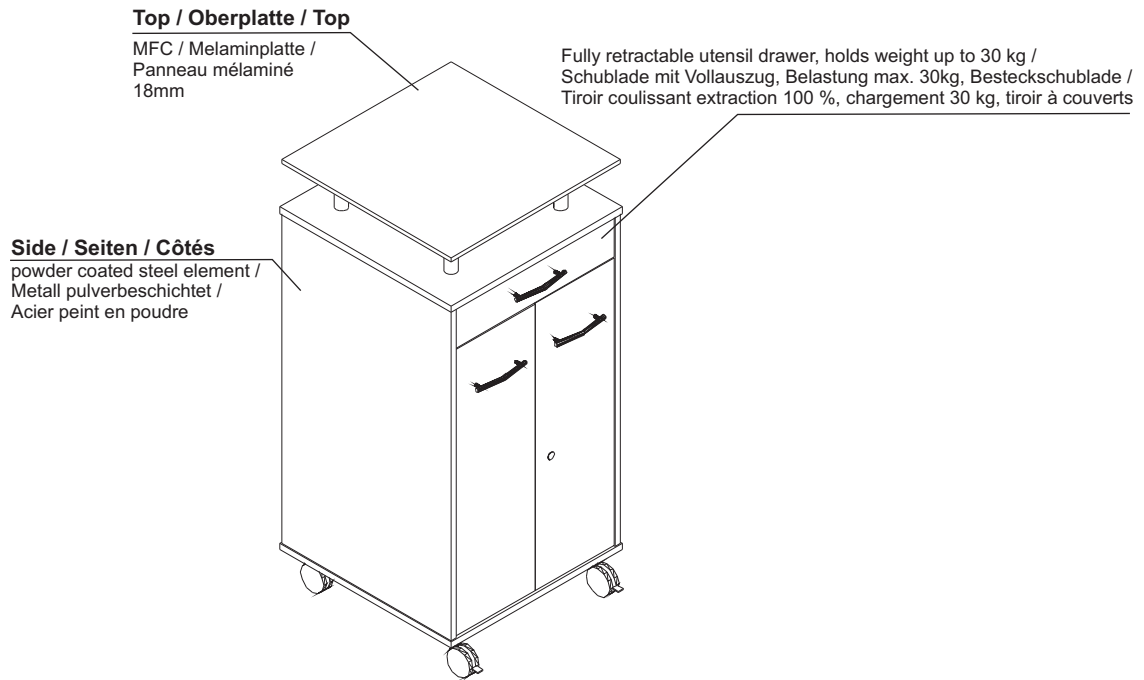

MOBILE ASSISTANT / MOBILE ASSISTENTEN / MOBILE ASSISTANT



FINISHES / FARBEN / FINITIONS

26-ALUMINUM SATINATO 67-WHITE PASTEL
ALUMINIUM SATINATO WEISS PASTELL
ALUMINIUM SATINE BLANC PASTEL



PRODUCT ILLUSTRATION / PRODUKTANSICHT UND SKIZZE / VUE DE PRODUIT	DIMENSIONS / ABMESSUNGEN [mm]			INDEX SYMBOL	PRICE EUR				ECO	COMMENTS / BEMERKUNGEN / REMARQUES
	WIDTH / BREITE / LARGEUR	DEPTH / TIEFE / PROFONDEUR	HEIGHT / HÖHE / HAUTEUR			kg	m3	pcs	EUR	

MOBILE, MULTI-FUNCTION STORAGE / MOBIL MULTISCHRANK / ARMOIRE MOBILE MULTIFUNCTION

	550	550	1188	A3R02		66.7	0.176	3	7.398	
---	-----	-----	------	--------------	--	------	-------	---	-------	--

DESCRIPTION / LEGENDE / LÉGENDE:

 net weight / Nettogewicht / poids net

 volume / Volumen / le volume

 number of packages / Stückzahl der Pakete / nombre de colis



STORAGEES / SCHRÄNKE / RANGEMENTS

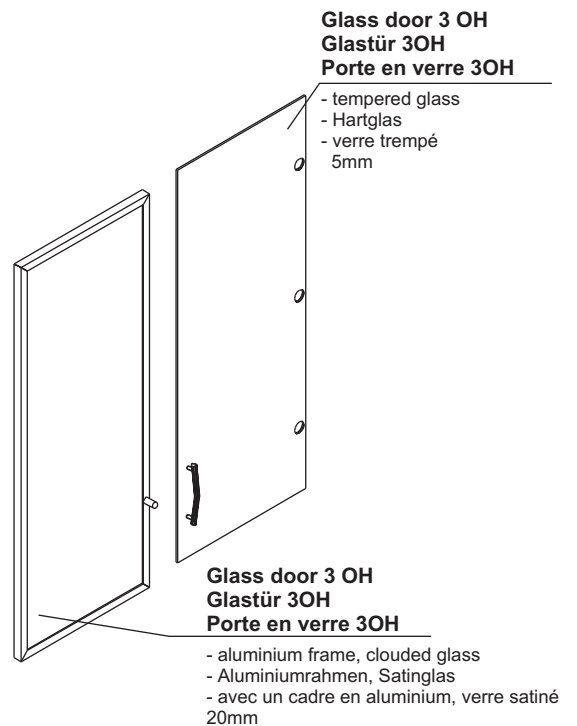
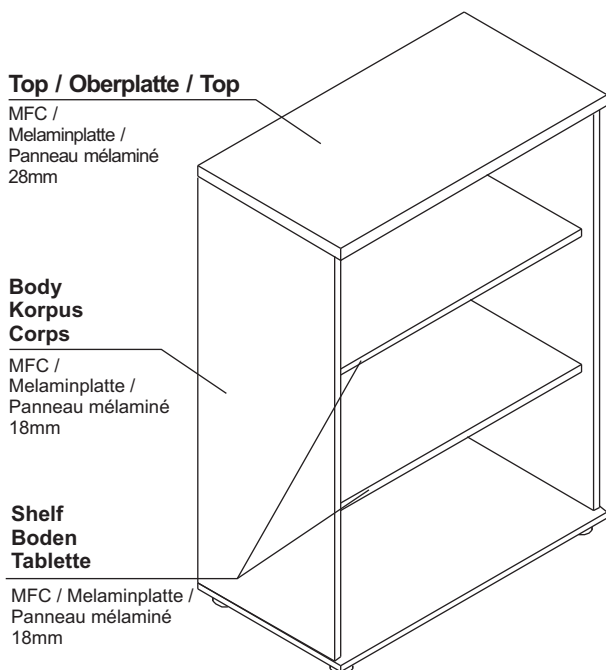
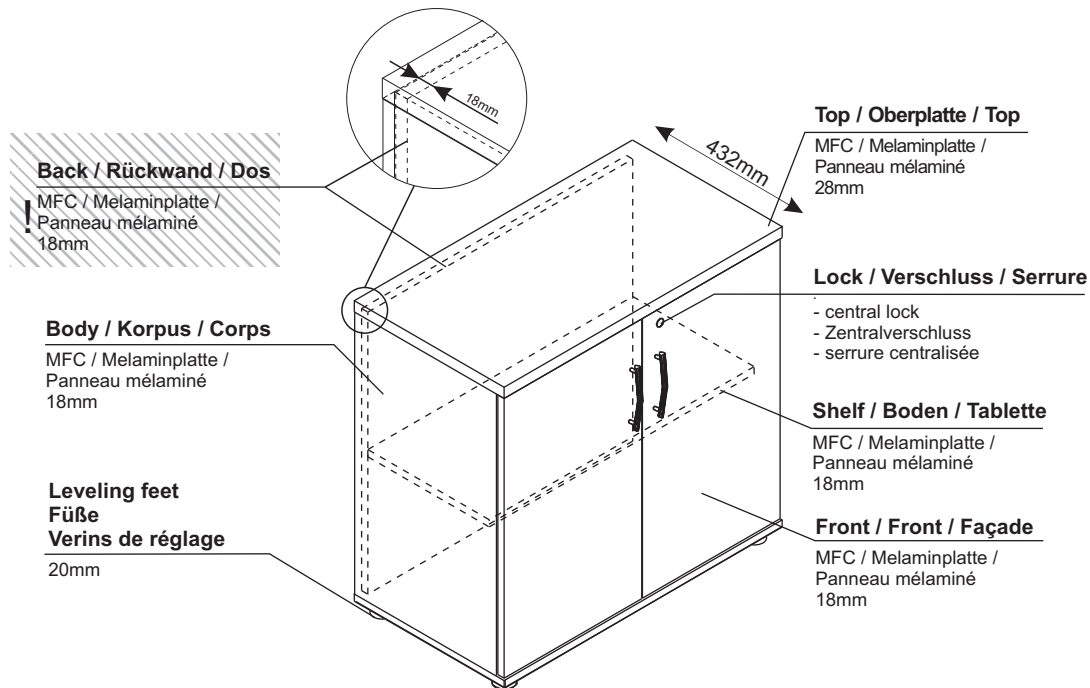



FINISHES / FARBEN / FINITIONS

Top, Bottom panel / Oberplatte, Sockel / Top, Plinthe

14-BEECH BUCHE HETRE	26-ALUMINUM SATINATO ALUMINIUM SATINATO ALUMINIUM SATINE	31-CANADIAN OAK KANADISCHE EICHE CHENE CANADIEN	34-CHESTNUT WENGE WENGE	39-POLAR BIRCH POLARBIEKERKE BOULEAU CLAIR	64-COCOA COCOA CACAO	67-WHITE PASTEL WEIß PASTELL BLANC PASTEL	106-LOWLAND NUT NUSSBAUM NOYER	
----------------------------	--	---	-------------------------------	--	----------------------------	---	--------------------------------------	---



Front / Front / Façade

14-BEECH BUCHE HETRE	26-ALUMINUM SATINATO ALUMINIUM SATINATO ALUMINIUM SATINE	31-CANADIAN OAK KANADISCHE EICHE CHENE CANADIEN	34-CHESTNUT WENGE WENGE	39-POLAR BIRCH POLARBIEKERKE BOULEAU CLAIR	64-COCOA COCOA CACAO	67-WHITE PASTEL WEIß PASTELL BLANC PASTEL	106-LOWLAND NUT NUSSBAUM NOYER	
----------------------------	--	---	-------------------------------	--	----------------------------	---	--------------------------------------	---



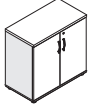

Body / Korpus / Corps

26-ALUMINUM SATINATO ALUMINIUM SATINATO ALUMINIUM SATINE	67-WHITE PASTEL WEIß PASTELL BLANC PASTEL						I - first group I – erste Gruppe I – première groupe de prix	
--	---	--	--	--	--	--	---	---

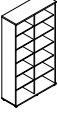

14-BEECH BUCHE HETRE	31-CANADIAN OAK KANADISCHE EICHE CHENE CANADIEN	34-CHESTNUT WENGE WENGE	39-POLAR BIRCH POLARBIEKERKE BOULEAU CLAIR	64-COCOA COCOA CACAO	106-LOWLAND NUT NUSSBAUM NOYER	II – second group II – zweite Gruppe II – deuxième groupe de prix		
----------------------------	---	-------------------------------	--	----------------------------	--------------------------------------	--	--	---

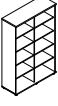
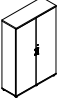
PRODUCT ILLUSTRATION / PRODUKTANSICHT UND SKIZZE / VUE DE PRODUIT	DIMENSIONS / ABMESSUNGEN [mm]			INDEX SYMBOL	PRICE EUR				ECO EUR	COMMENTS / BEMERKUNGEN / REMARQUES
	WIDTH / BREITE / LARGEUR	DEPTH / TIEFE / PROFONDEUR	HEIGHT / HÖHE / HAUTEUR			kg	m3	pcs		

STORAGE 1200MM WIDE / SCHRÄNKE UND REGALE 1200 MM / ARMOIRES ET RANGEMENTS DE 1200 MM

	1200	432	2185	A6506		98.0	0.219	2	10.878	
	1200	432	2185	A6106		128.0	0.303	3	14.208	espagnolette lock / Baskülenverschluss / serrure espagnolette
	1200	432	1833	A5506		83.0	0.185	2	9.213	
	1200	432	1833	A5106		108.0	0.256	3	11.988	espagnolette lock / Baskülenverschluss / serrure espagnolette
	1200	432	1129	A3506		54.0	0.119	2	5.994	
	1200	432	1129	A3106		69.0	0.164	3	7.659	

ADDITIONAL CHARGE / AUFPREIS FÜR SONDERAUSSTATTUNG / PLUS VALUE



	A6506	A6106	A5506	A5106	A3506	A3106							
										0.0	0.0000	0	
										1.0	0.0010	1	

DESCRIPTION / LEGENDE / LÉGENDE:







 net weight / Nettogewicht / poids net

 volume / Volumen / le volume

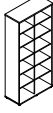

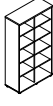
 number of packages / Stückzahl der Pakete / nombre de colis

PRODUCT ILLUSTRATION / PRODUKTANSICHT UND SKIZZE / VUE DE PRODUIT	DIMENSIONS / ABMESSUNGEN [mm]			INDEX SYMBOL	PRICE EUR				ECO	COMMENTS / BEMERKUNGEN / REMARQUES
	WIDTH / BREITE / LARGEUR	DEPTH / TIEFE / PROFONDEUR	HEIGHT / HÖHE / HAUTEUR			kg	m3	pcs	EUR	

STORAGEES 1000M WIDE / SCHRÄNKE UND REGALE 1000 MM / ARMOIRES ET RANGEMENTS DE 1000 MM

	1000	432	2185	A6505		86.0	0.184	2	9.546	
	1000	432	2185	A6105		112.0	0.255	3	12.432	espagnolette lock / Baskilerverschluss / serrure espagnolette
	1000	432	1833	A5505		74.0	0.159	2	8.214	
	1000	432	1833	A5105		95.0	0.219	3	10.545	espagnolette lock / Baskilerverschluss / serrure espagnolette
	1000	432	1129	A3505		48.0	0.100	2	5.328	
	1000	432	1129	A3105		61.0	0.138	3	6.771	

ADDITIONAL CHARGE / AUFPREIS FÜR SONDERAUSSTATTUNG / PLUS VALUE



	A6505	A6105	A5505	A5105	A3505	A3105							
										0.0	0.0000	0	
										1.0	0.0010	1	

DESCRIPTION / LEGENDE / LÉGENDE:



 net weight / Nettogewicht / poids net

 volume / Volumen / le volume

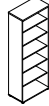
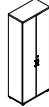
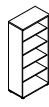
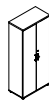
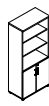
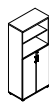

 number of packages / Stückzahl der Pakete / nombre de colis

PRODUCT ILLUSTRATION / PRODUKTANSICHT UND SKIZZE / VUE DE PRODUIT	DIMENSIONS / ABMESSUNGEN [mm]			INDEX SYMBOL	PRICE EUR				ECO EUR	COMMENTS / BEMERKUNGEN / REMARQUES
	WIDTH / BREITE / LARGEUR	DEPTH / TIEFE / PROFONDEUR	HEIGHT / HÖHE / HAUTEUR			kg	m3	pcs		

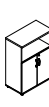
STORAGES 800MM WIDE / SCHRÄNKE UND REGALE FÜR 800 MM / ARMOIRES ET RANGEMENTS DE 800 MM

	801	432	2185	A6504		67.0	0.167	2	7.437	
	801	432	2185	A6104		144.0	0.367	4	15.984	additional feature: espagnolette lock, 40 euro / zusätzliche Eigenschaft: Baskülenverschluss gegen Aufpreis von 88 PLN / Prix supplémentaire: serrure espagnolette payee 88 euros de plus
	801	432	1833	A5504		58.0	0.167	2	6.438	
	801	432	1833	A5104		93.7	0.257	4	10.395	additional feature: espagnolette lock, 40 euro / zusätzliche Eigenschaft: Baskülenverschluss gegen Aufpreis von 40 Euro / Prix supplémentaire: serrure espagnolette payee 40 euros de plus
	801	432	1833	A5404		65.0	0.187	3	7.215	
	801	432	1833	A5304		69.3	0.194	3	7.692	
	801	432	1129	A3504		37.0	0.091	2	4.107	
	801	432	1129	A3104		44.3	0.116	3	4.917	
	801	432	1129	A3404		40.0	0.109	3	4.440	

ADDITIONAL CHARGE / AUFPREIS FÜR SONDERAUSSTATTUNG / PLUS VALUE



	A6504	A6104	A5504	A5104	A5404	A5304	A3504	A3104	A3404				
										0.0	0.0000	0	
										1.0	0.0010	1	

DESCRIPTION / LEGENDE / LÉGENDE:



 net weight / Nettogewicht / poids net

 volume / Volumen / le volume



 number of packages / Stückzahl der Pakete / nombre de colis

PRODUCT ILLUSTRATION / PRODUKTANSICHT UND SKIZZE / VUE DE PRODUIT	DIMENSIONS / ABMESSUNGEN [mm]			INDEX SYMBOL	PRICE EUR				ECO	COMMENTS / BEMERKUNGEN / REMARQUES
	WIDTH / BREITE / LARGEUR	DEPTH / TIEFE / PROFONDEUR	HEIGHT / HÖHE / HAUTEUR			kg	m3	pcs	EUR	

STORAGEES 800MM WIDE / SCHRÄNKE UND REGALE FÜR 800 MM / ARMOIRES ET RANGEMENTS DE 800 MM

	801	432	1129	A3F04		52.7	0.421	1	5.850	suspension file drawers / Schublade für file drawer ohne Boden / tiroir a dossiers suspendus sans fond
	801	432	777	A2504		28.0	0.071	2	3.108	
	801	432	777	A2104		35.0	0.091	3	3.885	

ADDITIONAL CHARGE / AUFPREIS FÜR SONDERAUSSTATTUNG / PLUS VALUE



	A3F04	A2504	A2104										
										0.0	0.0000	0	
										1.0	0.0010	1	

DESCRIPTION / LEGENDE / LÉGENDE:









 net weight / Nettogewicht / poids net

 volume / Volumen / le volume



 number of packages / Stückzahl der Pakete / nombre de colis

PRODUCT ILLUSTRATION / PRODUKTANSICHT UND SKIZZE / VUE DE PRODUIT	DIMENSIONS / ABMESSUNGEN [mm]			INDEX SYMBOL	PRICE EUR				ECO	COMMENTS / BEMERKUNGEN / REMARQUES
	WIDTH / BREITE / LARGEUR	DEPTH / TIEFE / PROFONDEUR	HEIGHT / HÖHE / HAUTEUR			kg	m3	pcs	EUR	

STORAGEES 400MM WIDE / SCHRÄNKE UND REGALE 400 MM / ARMOIRES ET RANGEMENTS DE 400MM

	402	432	1833	A5902		38.0	0.083	2	4.218	
	402	432	1833	A58P2		40.0	0.096	2	4.440	right door / rechte Tür / porte droite
	402	432	1833	A56P2		84.0	0.179	3	9.324	right door / rechte Tür / porte droite
	402	432	1129	A3902		24.0	0.059	2	2.664	
	402	432	1129	A38P2		28.0	0.063	2	3.108	right door / rechte Tür / porte droite
	402	432	1129	A36P2		29.0	0.064	2	3.219	right door / rechte Tür / porte droite
	402	432	777	A2902		18.0	0.041	2	1.998	
	402	432	777	A26P2		21.0	0.048	2	2.331	right door / rechte Tür / porte droite

ADDITIONAL CHARGE / AUFPREIS FÜR SONDERAUSSTATTUNG / PLUS VALUE



	A5902	A58P2	A56P2	A3902	A38P2	A36P2	A2902	A26P2						
											0.0	0.0000	0	
											1.0	0.0010	1	

DESCRIPTION / LEGENDE / LÉGENDE:



 net weight / Nettogewicht / poids net

 volume / Volumen / le volume

 number of packages / Stückzahl der Pakete / nombre de colis

PRODUCT ILLUSTRATION / PRODUKTANSICHT UND SKIZZE / VUE DE PRODUIT	DIMENSIONS / ABMESSUNGEN [mm]			INDEX SYMBOL	PRICE EUR				ECO	COMMENTS / BEMERKUNGEN / REMARQUES
	WIDTH / BREITE / LARGEUR	DEPTH / TIEFE / PROFONDEUR	HEIGHT / HÖHE / HAUTEUR			kg	m3	pcs	EUR	



2H STACK-ON STORAGE / ANSATZSTÜCKE 2OH / REHAUSSES 2OH

	402	432	750	A16P2		21.0	0.048	2	2.331	right door / rechte Tür / porte droite
	402	432	750	A1902		18.0	0.041	2	1.998	
	801	432	750	A1104		30.0	0.072	3	3.330	
	801	432	750	A1504		23.0	0.052	2	2.553	

MANAGERIAL STORAGE / MANAGERSCHRANK / RANGEMENT

	1400	432	600	A14M		57.5	0.152	4	6.383	universal storage left or right / Universalschrank, links oder rechts / armoire universelle, gauche ou droite
--	------	-----	-----	-------------	--	------	-------	---	-------	---

ADDITIONAL CHARGE / AUFPREIS FÜR SONDERAUSSTATTUNG / PLUS VALUE

FEATURE / EIGENSCHAFT / ATTRIBUT	PRODUCT / SYMBOL / PRODUITS											COMMENTS / BEMERKUNGEN / REMARQUES
									kg	m3	pcs	
II PRICE GROUP / II PREISGRUPPE / II GROUPE DE PRIX.								0.0	0.0000	0		
Wide angle hinge / Weitwinkelscharnier / Charnière a grand								1.0	0.0010	1		

DESCRIPTION / LEGENDE / LÉGENDE:

 net weight / Nettogewicht / poids net

 volume / Volumen / le volume

 number of packages / Stückzahl der Pakete / nombre de colis



WARDROBES / KLEIDERSCHRANK / VESTIAIRES

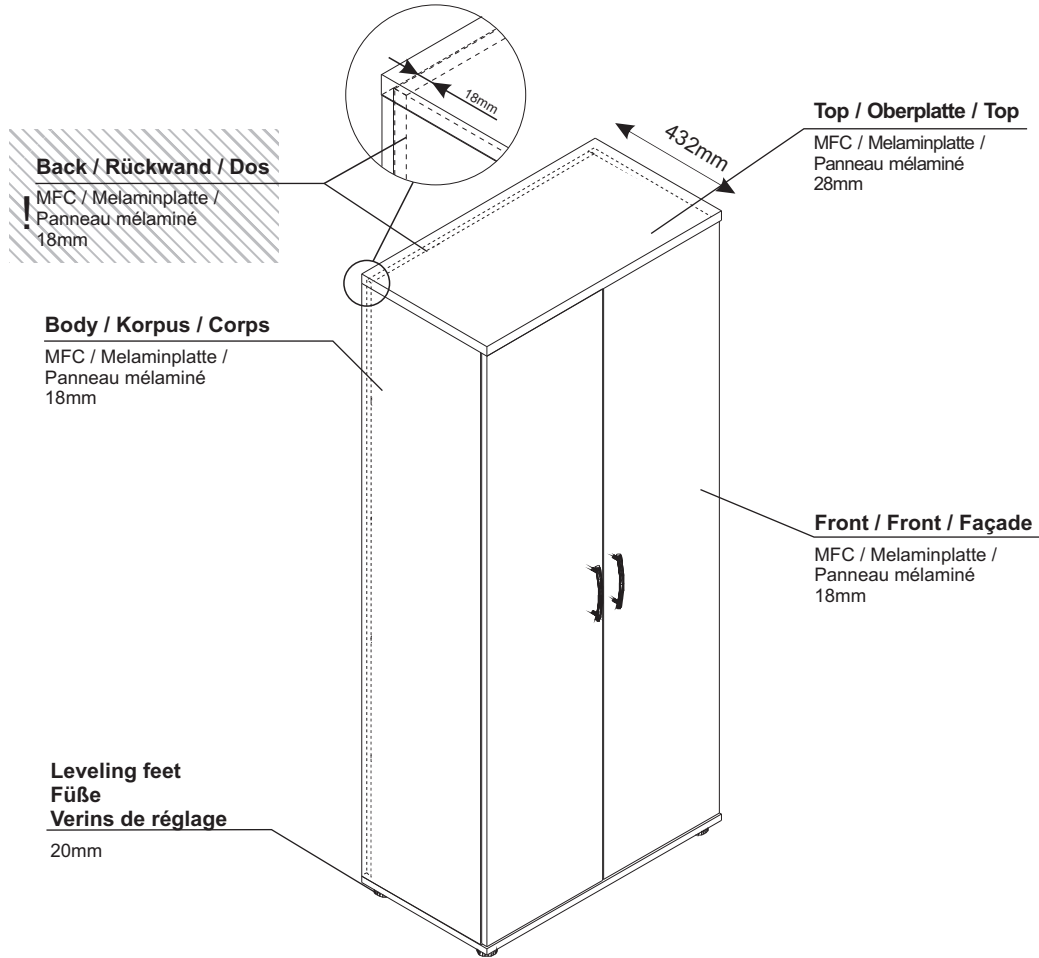

A57P3

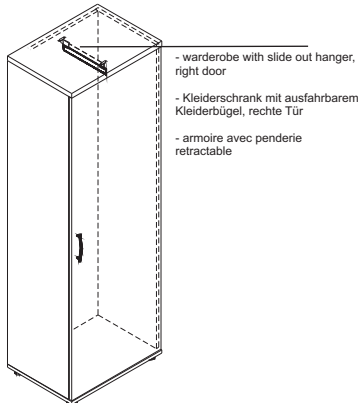

A52P4

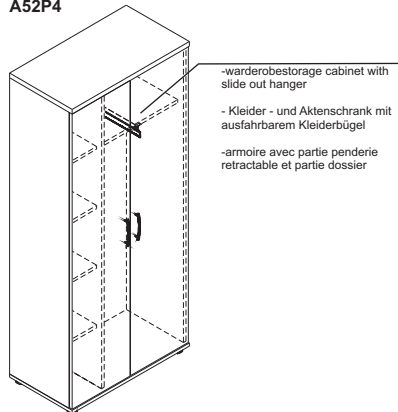

A6204

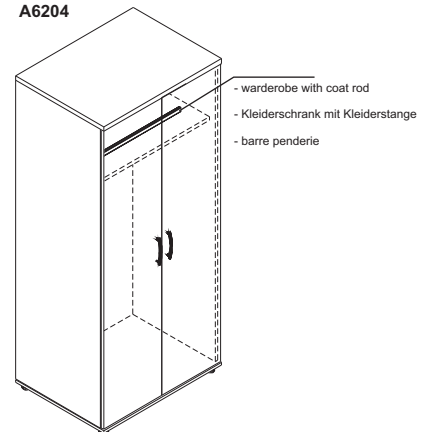



FINISHES / FARBEN / FINITIONS



Top, Bottom panel / Oberplatte, Sockel / Top, Plinthe



14-BEECH BUCHE HETRE	26-ALUMINUM SATINATO ALUMINIUM SATINATO ALUMINIUM SATINE	31-CANADIAN OAK KANADISCHE EICHE CHENE CANADIEN	34-CHESTNUT WENGE WENGE	39-POLAR BIRCH POLARBIEKERKE BOULEAU CLAIR	64-COCOA COCOA CACAO	67-WHITE PASTEL WEISS PASTELL BLANC PASTEL	106-LOWLAND NUT NUSSBAUM NOYER	
----------------------------	--	---	-------------------------------	--	----------------------------	--	--------------------------------------	---

Front / Front / Façade

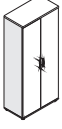

14-BEECH BUCHE HETRE	26-ALUMINUM SATINATO ALUMINIUM SATINATO ALUMINIUM SATINE	31-CANADIAN OAK KANADISCHE EICHE CHENE CANADIEN	34-CHESTNUT WENGE WENGE	39-POLAR BIRCH POLARBIEKERKE BOULEAU CLAIR	64-COCOA COCOA CACAO	67-WHITE PASTEL WEISS PASTELL BLANC PASTEL	106-LOWLAND NUT NUSSBAUM NOYER	
----------------------------	--	---	-------------------------------	--	----------------------------	--	--------------------------------------	---

Body / Korpus / Corps



26-ALUMINUM SATINATO ALUMINIUM SATINATO ALUMINIUM SATINE	67-WHITE PASTEL WEISS PASTELL BLANC PASTEL							I - first group I – erste Gruppe I – première groupe de prix	
14-BEECH BUCHE HETRE	31-CANADIAN OAK KANADISCHE EICHE CHENE CANADIEN	34-CHESTNUT WENGE WENGE	39-POLAR BIRCH POLARBIEKERKE BOULEAU CLAIR	64-COCOA COCOA CACAO	106-LOWLAND NUT NUSSBAUM NOYER	II – second group II – zweite Gruppe II – deuxième groupe de prix			

PRODUCT ILLUSTRATION / PRODUKTANSICHT UND SKIZZE / VUE DE PRODUIT	DIMENSIONS / ABMESSUNGEN [mm]			INDEX SYMBOL	PRICE EUR				ECO EUR	COMMENTS / BEMERKUNGEN / REMARQUES
	WIDTH / BREITE / LARGEUR	DEPTH / TIEFE / PROFONDEUR	HEIGHT / HÖHE / HAUTEUR			kg	m3	pcs		

WARDROBES / KLEIDERSCHRANK / VESTIAIRES

	602	432	1833	A57P3		96.0	0.252	3	10.656	wardrobe with slide out hanger, right door / Kleiderschrank mit ausfahrbarem Kleiderbügel, rechte Tür / armoire avec penderie retractable
	801	600	1833	A6204		89.0	0.239	4	9.879	wardrobe with coat rod / Kleiderschrank mit Kleiderstange / barre penderie
	801	432	1833	A52P4		93.0	0.263	4	10.323	wardrobe storage cabinet with slide out hanger / Kleider- und Aktenschrank mit ausfahrbarem Kleiderbügel / armoire avec partie penderie retractable et partie dossier

ADDITIONAL CHARGE / AUFPREIS FÜR SONDERAUSSTATTUNG / PLUS VALUE

													
	A57P3	A6204	A52P4										
										0.0	0.0000	0	
										1.0	0.0010	1	

DESCRIPTION / LEGENDE / LÉGENDE:

 net weight / Nettogewicht / poids net

 volume / Volumen / le volume

 number of packages / Stückzahl der Pakete / nombre de colis



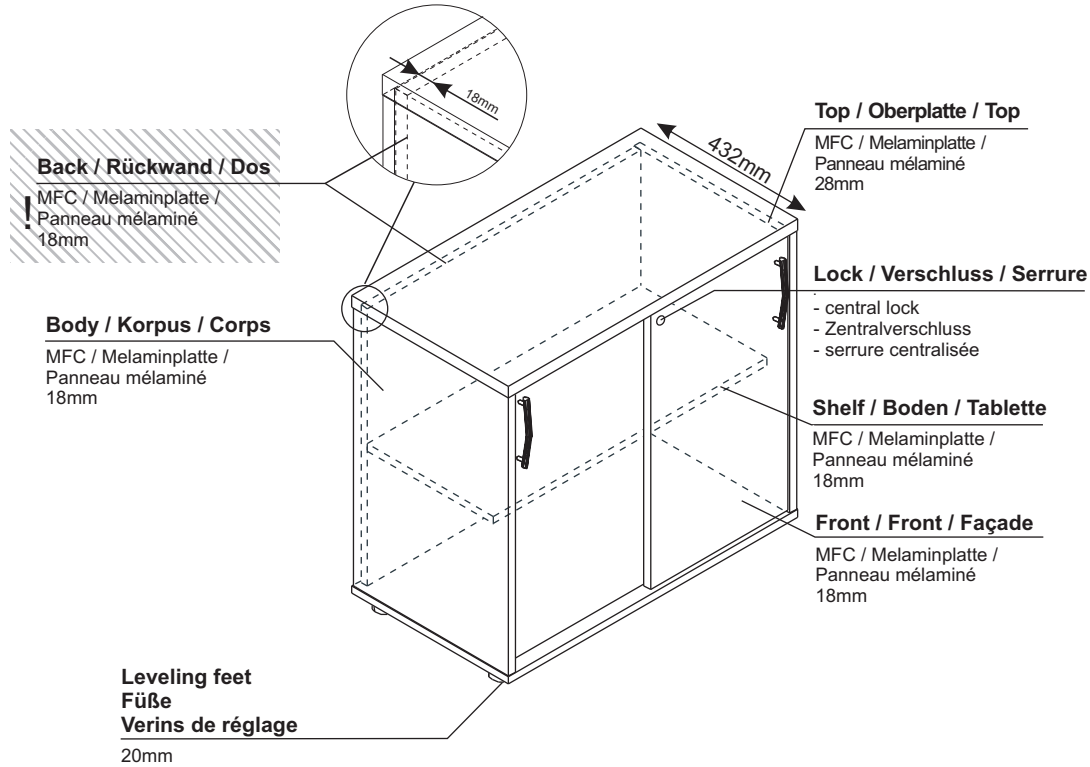

STORAGEES / SCHRÄNKE / RANGEMENTS







FINISHES / FARBEN / FINITIONS

Top, Bottom panel / Oberplatte, Sockel / Top, Plinthe



14-BEECH BÜCHE HETRE	26-ALUMINUM SATINATO ALUMINIUM SATINATO ALUMINIUM SATINE	31-CANADIAN OAK KANADISCHE EICHE CHENE CANADIEN	34-CHESTNUT WENGE WENGE	39-POLAR BIRCH POLARBIERKE BOULEAU CLAIR	64-COCOA COCOA CACAO	67-WHITE PASTEL WEIß PASTELL BLANC PASTEL	106-LOWLAND NUT NUSSBAUM NOYER		
Front / Front / Façade									
14-BEECH BÜCHE HETRE	26-ALUMINUM SATINATO ALUMINIUM SATINATO ALUMINIUM SATINE	31-CANADIAN OAK KANADISCHE EICHE CHENE CANADIEN	34-CHESTNUT WENGE WENGE	39-POLAR BIRCH POLARBIERKE BOULEAU CLAIR	64-COCOA COCOA CACAO	67-WHITE PASTEL WEIß PASTELL BLANC PASTEL	106-LOWLAND NUT NUSSBAUM NOYER		
26-ALUMINUM SATINATO ALUMINIUM SATINATO ALUMINIUM SATINE							67-WHITE PASTEL WEIß PASTELL BLANC PASTEL	I - first group I – erste Gruppe I – première groupe de prix	
14-BEECH BÜCHE HETRE	31-CANADIAN OAK KANADISCHE EICHE CHENE CANADIEN	34-CHESTNUT WENGE WENGE	39-POLAR BIRCH POLARBIERKE BOULEAU CLAIR	64-COCOA COCOA CACAO	106-LOWLAND NUT NUSSBAUM NOYER	II – second group II – zweite Gruppe II – deuxième groupe de prix			

PRODUCT ILLUSTRATION / PRODUKTANSICHT UND SKIZZE / VUE DE PRODUIT	DIMENSIONS / ABMESSUNGEN [mm]			INDEX SYMBOL	PRICE EUR				ECO	COMMENTS / BEMERKUNGEN / REMARQUES
	WIDTH / BREITE / LARGEUR	DEPTH / TIEFE / PROFONDEUR	HEIGHT / HÖHE / HAUTEUR			kg	m3	pcs	EUR	

SLIDING DOORS STORAGEES / SCHRÄNKE MIT SCHIEBETÜREN / ARMOIRES À PORTES COULISSANTES

	800	432	740	A2P04		35.0	0.092	3	3.885	
	1200	432	740	A2P06		41.0	0.120	3	4.551	
	1200	432	750	A1P06		52.0	0.124	3	5.772	
	1200	432	1129	A3P06		75.0	0.174	3	8.325	
	1200	432	1833	A5P06		103.0	0.260	3	11.433	

ADDITIONAL CHARGE / AUFFREIS FÜR SONDERAUSSTATTUNG / PLUS VALUE

									
	A2P04	A2P06	A1P06	A3P06	A5P06				
						0.0	0.0000	0	

DESCRIPTION / LEGENDE / LÉGENDE:

 net weight / Nettogewicht / poids net

 volume / Volumen / le volume

 number of packages / Stückzahl der Pakete / nombre de colis



STORAGEES / SCHRÄNKE / RANGEMENTS

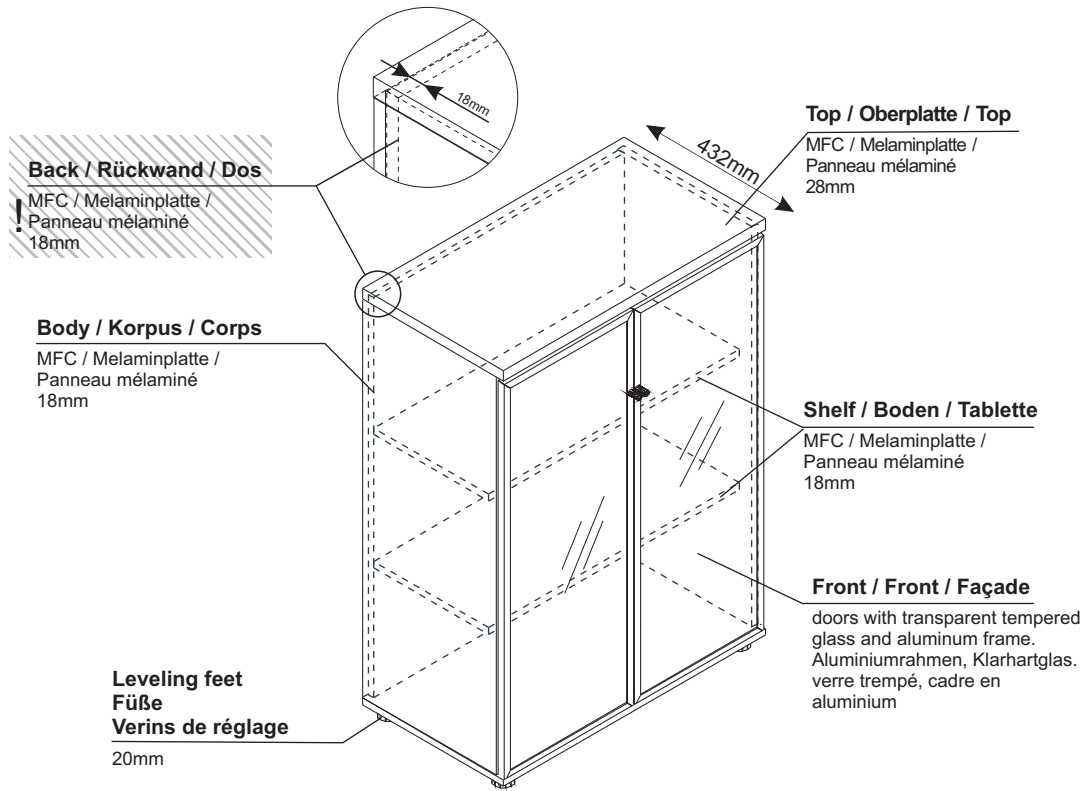

FINISHES / FARBEN / FINITIONS

Top, Bottom panel / Oberplatte, Sockel / Top, Plinthe

- | | | | | | | | |
|----------------------------|---|---|-------------------------------|--|----------------------------|---|--------------------------------------|
| 14-BEECH
BUCHE
HETRE | 26-ALUMINIUM SATINATO
ALUMINIUM SATINATO
ALUMINIUM SATINE | 31-CANADIAN OAK
KANADISCHE EICHE
CHENE CANADIEN | 34-CHESTNUT
WENGE
WENGE | 39-POLAR BIRCH
POLARBIERKE
BOULEAU CLAIR | 64-COCOA
COCOA
CACAO | 67-WHITE PASTEL
WEIß PASTELL
BLANC PASTEL | 106-LOWLAND NUT
NUSSBAUM
NOYER |
|----------------------------|---|---|-------------------------------|--|----------------------------|---|--------------------------------------|

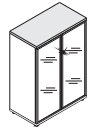

Front / Front / Façade

09-ALUMINIUM
ALUMINIUM
ALUMINIUM



doors with transparent tempered glass and aluminum frame.
Aluminiumrahmen, Klarhartglas.
verre trempé, cadre en aluminium

Body / Korpus / Corps

26-ALUMINIUM SATINATO 67-WHITE PASTEL
ALUMINIUM SATINATO WEIß PASTELL
ALUMINIUM SATINE BLANC PASTEL

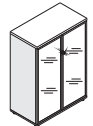

I - first group
I - erste Gruppe
I - première
groupe de prix



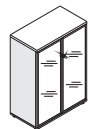

14-BEECH BUCHE HETRE	31-CANADIAN OAK KANADISCHE EICHE CHENE CANADIEN	34-CHESTNUT WENGE WENGE	39-POLAR BIRCH POLARBIERKE BOULEAU CLAIR	64-COCOA COCOA CACAO	106-LOWLAND NUT NUSSBAUM NOYER
----------------------------	---	-------------------------------	--	----------------------------	--------------------------------------

II - second group
II - zweite Gruppe
II - deuxième
groupe de prix





PRODUCT ILLUSTRATION / PRODUKTANSICHT UND SKIZZE / VUE DE PRODUIT	DIMENSIONS / ABMESSUNGEN [mm]			INDEX SYMBOL	PRICE EUR				ECO EUR	COMMENTS / BEMERKUNGEN / REMARQUES
	WIDTH / BREITE / LARGEUR	DEPTH / TIEFE / PROFONDEUR	HEIGHT / HÖHE / HAUTEUR			kg	m3	pcs		

STORAGES WITH GLASS DOORS / VITRINEN / ARMOIRES AVEC DES FAÇADES EN VERRE

	801	432	1833	A5104W		74.0	0.232	3	8.214	glass door in aluminum frame / Glastür im Aluminiumrahmen / porte vitrée, cadre en Aluminium
	801	432	1129	A3104W		47.0	0.130	3	5.217	glass door in aluminum frame / Glastür im Aluminiumrahmen / porte vitrée, cadre en Aluminium

DESCRIPTION / LEGENDE / LÉGENDE:

 net weight / Nettogewicht / poids net

 volume / Volumen / le volume

 number of packages / Stückzahl der Pakete / nombre de colis



STORAGEES / SCHRÄNKE / RANGEMENTS

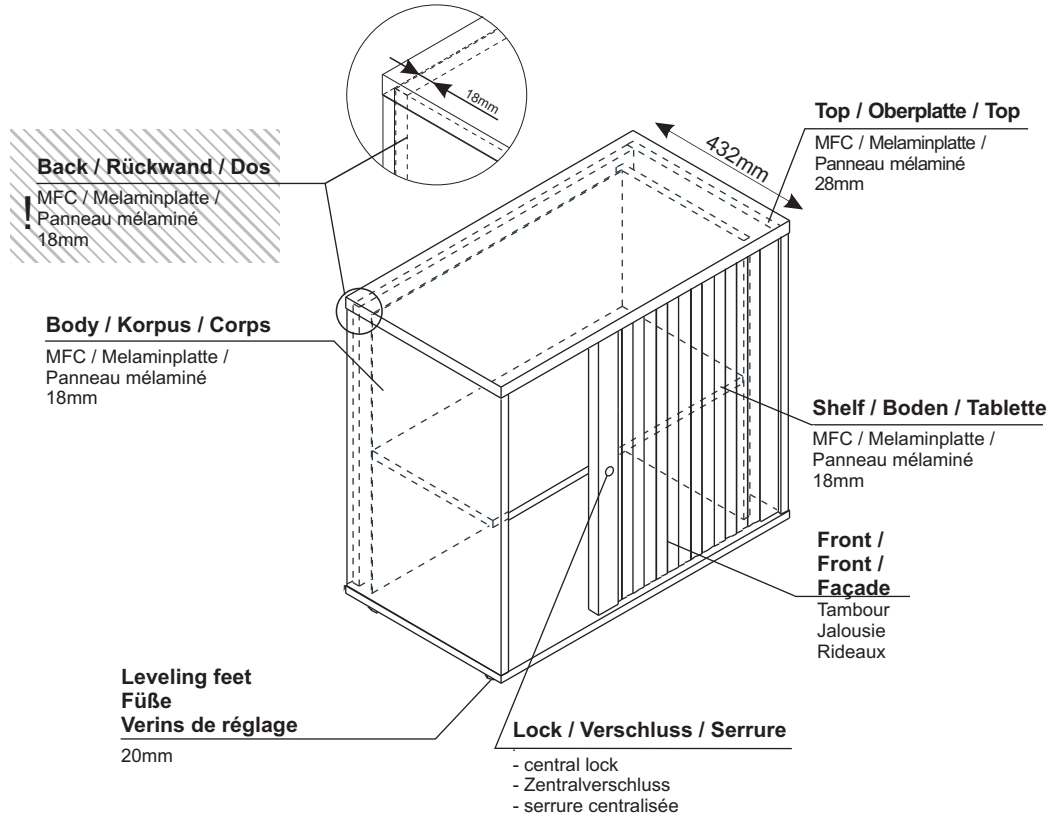

FINISHES / FARBEN / FINITIONS

Top, Bottom panel / Oberplatte, Sockel / Top, Plinthe

08-BLACK SCHWARZ NOIR	14-BEECH BÜCHE HETRE	26-ALUMINIUM SATINATO ALUMINIUM SATINATO ALUMINIUM SATINE	31-CANADIAN OAK KANADISCHE EICHE CHENE CANADIEN	34-CHESTNUT WENGE WENGE
39-POLAR BIRCH POLARBIEKERKE BOULEAU CLAIR	64-COCOA COCOA CACAO	67-WHITE PASTEL WEIß PASTELL BLANC PASTEL	106-LOWLAND NUT NUSSBAUM NOYER	

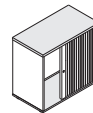

Tambour / Jalousie / Rideaux

30-WHITE WEIß BLANC	08-BLACK SCHWARZ NOIR	09-ALUMINIUM ALUMINIUM ALUMINIUM
---------------------------	-----------------------------	--

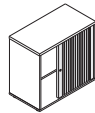

Body / Korpus / Corps

67-WHITE PASTEL WEIß PASTELL BLANC PASTEL	08-BLACK SCHWARZ NOIR	09-ALUMINIUM ALUMINIUM ALUMINIUM
---	-----------------------------	--

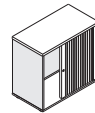



I - first group
I - erste Gruppe
I - première
groupe de prix

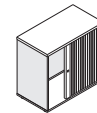

14-BEECH BÜCHE HETRE	31-CANADIAN OAK KANADISCHE EICHE CHENE CANADIEN	34-CHESTNUT WENGE WENGE	39-POLAR BIRCH POLARBIEKERKE BOULEAU CLAIR	64-COCOA COCOA CACAO	106-LOWLAND NUT NUSSBAUM NOYER
----------------------------	---	-------------------------------	--	----------------------------	--------------------------------------





II - second group
II - zweite Gruppe
II - deuxième
groupe de prix

PRODUCT ILLUSTRATION / PRODUKTANSICHT UND SKIZZE / VUE DE PRODUIT	DIMENSIONS / ABMESSUNGEN [mm]			INDEX SYMBOL	PRICE EUR				ECO	COMMENTS / BEMERKUNGEN / REMARQUES
	WIDTH / BREITE / LARGEUR	DEPTH / TIEFE / PROFONDEUR	HEIGHT / HÖHE / HAUTEUR			kg	m3	pcs	EUR	

TAMBOUR STORAGES / JALOUSIESCHRÄNKE / ARMOIRES À RIDEAUX

	800	432	740	A2L04		32.6	0.303	1	3.613	
	1200	432	740	A2L06		46.5	0.464	1	5.161	
	1200	432	1129	A3L06		64.4	0.673	1	7.148	

ADDITIONAL CHARGE / AUFPREIS FÜR SONDERAUSSTATTUNG / PLUS VALUE

													
	A2L04	A2L06	A3L06										
										0.0	0.0000	0	

DESCRIPTION / LEGENDE / LÉGENDE:

 net weight / Nettogewicht / poids net

 volume / Volumen / le volume

 number of packages / Stückzahl der Pakete / nombre de colis

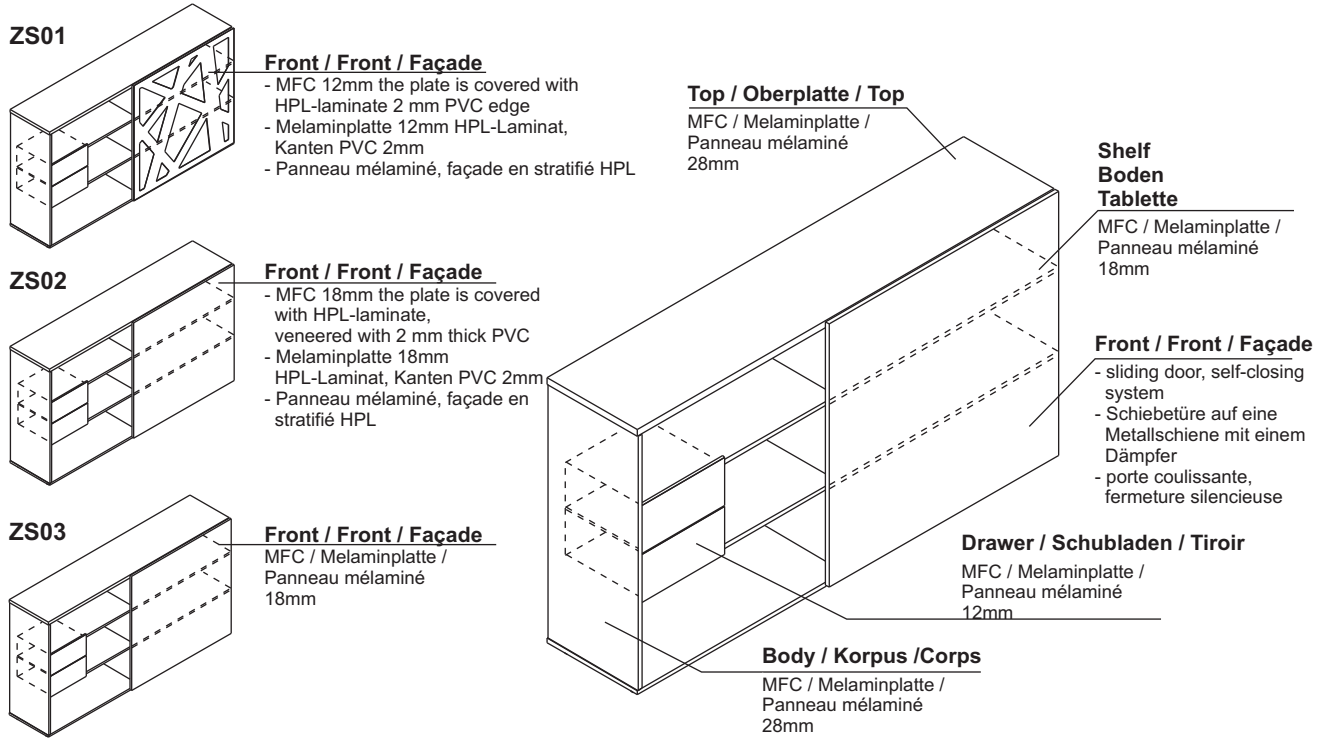

FINISHES / FARBEN / FINITIONS

ZS01

67-WHITE PASTEL WEIß PASTELL BLANC PASTEL	73-HIGH GLOSS WHITE WEIß GLANZ BLANC BRILLANT	15-WHITE WEIß BLANC	
---	---	---------------------------	--

ZS02 | Top, Bottom panel / Oberplatte, Sockel / Top, Plinthe

67-WHITE PASTEL WEIß PASTELL BLANC PASTEL	26-ALUMINIUM SATINATO ALUMINIUM SATINATO ALUMINIUM SATINE	
---	---	--

ZS02 | Front HPL / Front HPL / Façade HPL

72-HIGH GLOSS LIME GRÜN GLANZ VERT BRILLANT	73-HIGH GLOSS WHITE WEIß GLANZ BLANC BRILLANT	74-HIGH GLOSS ORANGE ORANGE GLANZ ORANGE BRILLANT	82-HIGH GLOSS RED ROT GLANZ ROUGE BRILLANT	101- HIGH GLOSS BLACK SCHWARZ GLANZ NOIR BRILLANT	
---	---	---	--	---	--

ZS03 | Body / Korpus / Corps



67-WHITE PASTEL WEIß PASTELL BLANC PASTEL	26-ALUMINIUM SATINATO ALUMINIUM SATINATO ALUMINIUM SATINE	
---	---	--

ZS03 | Top, Bottom panel / Oberplatte, Sockel / Top, Plinthe



31-CANADIAN OAK KANADISCHE EICHE CHENE CANADIEN	34-CHESTNUT WENGE WENGE	39-POLAR BIRCH POLARBIEKERKE BOULEAU CLAIR	67-WHITE PASTEL WEIß PASTELL BLANC PASTEL	
---	-------------------------------	--	---	--

ZS03 | Front / Front / Façade

31-CANADIAN OAK KANADISCHE EICHE CHENE CANADIEN	34-CHESTNUT WENGE WENGE	39-POLAR BIRCH POLARBIEKERKE BOULEAU CLAIR	67-WHITE PASTEL WEIß PASTELL BLANC PASTEL	
---	-------------------------------	--	---	--

PRODUCT ILLUSTRATION / PRODUKTANSICHT UND SKIZZE / VUE DE PRODUIT	DIMENSIONS / ABMESSUNGEN [mm]			INDEX SYMBOL	PRICE EUR				ECO	COMMENTS / BEMERKUNGEN / REMARQUES
	WIDTH / BREITE / LARGEUR	DEPTH / TIEFE / PROFONDEUR	HEIGHT / HÖHE / HAUTEUR			kg	m3	pcs	EUR	

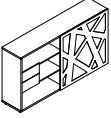
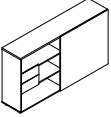
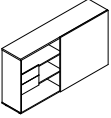
SLIDING DOORS STORAGEES / SCHRÄNKE MIT SCHIEBETÜR / ARMOIRES À PORTES COULISSANTES



	2000	434	1129	ZS01		114.2	0.331	5	12.671	ZIG-ZAG front / ZIG-ZAG-Front / façade ZIG-ZAG
	2000	434	1129	ZS02		122.2	0.331	5	13.559	HPL front / HPL-Front / façade en stratifié
	2000	434	1129	ZS03		114.2	0.331	5	12.671	mfc front / Frontplatte - Melamin / façade en mélaminé
	428	385	403	ZSZ01		10.2	0.075	1	1.127	additional drawer for storage ZS01, ZS02, ZS03 / zusätzliche Schublade für Schränke ZS01, ZS02 und ZS03 / tiroir supplémentaire pour l'armoire ZS01,ZS02 et ZS03

DESCRIPTION / LEGENDE / LÉGENDE:





 net weight / Nettogewicht / poids net

 volume / Volumen / le volume

 number of packages / Stückzahl der Pakete / nombre de colis

PRODUCT ILLUSTRATION / PRODUKTANSICHT UND SKIZZE / VUE DE PRODUIT	DIMENSIONS / ABMESSUNGEN [mm]			INDEX SYMBOL	PRICE EUR				ECO EUR	COMMENTS / BEMERKUNGEN / REMARQUES
	WIDTH / BREITE / LARGEUR	DEPTH / TIEFE / PROFONDEUR	HEIGHT / HÖHE / HAUTEUR			kg	m3	pcs		

ACCESSORIES / ZUBEHÖR / ACCESSOIRES

	397	5	1050	AS31		6.5	0.034	1	0.722	universal glass door (1pcs) 3h, transparent tempered glass / universale Glastür (1 Sck.) 3OH, durchsichtiges Sicherheitsglas / porte vitrée (1 pièce) 3OH, universelle, verre trempé transparent
	397	20	1050	AS29		5.0	0.022	1	0.555	universal glass door (1pcs) 3h with aluminum frame, frosted tempered glass / universale Glastür (1 Sck.) 3OH, durchsichtiges Sicherheitsglas / porte vitrée (1 pièce) 3OH, universelle, avec cadre aluminium,
	397	20	1050	AS30		5.0	0.022	1	0.555	glass door (1pcs) 3h aluminum frame, frosted tempered glass / universale Glastür (1 Sck.) 3OH, mit Aluminiumrahmen, gehärtetes Milchglas / porte en verre(1pc) universel, 3OH, cadre en aluminium, verre trempé satiné
	800	20	1050	AS300		10.3	0.037	1	1.143	glass doors (2pcs) 3h aluminum frame, frosted tempered glass / universale Glastüren (2 Sck.) 3OH, mit Aluminiumrahmen, gehärtetes Milchglas / portes en verre(1pc) universel, 3OH, cadre en aluminium, verre trempé satiné
	710	600	600	S85		32.0	0.066	1	3.552	under printer storage, all in 26-aluminum satinato or 67-white pastel / Kopierer-Schrank, ganz in Farbe 26 - aluminium satinati oder 67 - pastellweiß / rangement pour mettre une photocopieuse dessus, tout en couleur 26 ALUMINIUM

DESCRIPTION / LEGENDE / LÉGENDE:

 net weight / Nettogewicht / poids net

 volume / Volumen / le volume

 number of packages / Stückzahl der Pakete / nombre de colis



STORAGES WITH METAL SHELVES / SCHRÄNKE UND REGALE MIT METALLFACHBODEN / ARMOIRES AVEC TABLETTES EN METAL

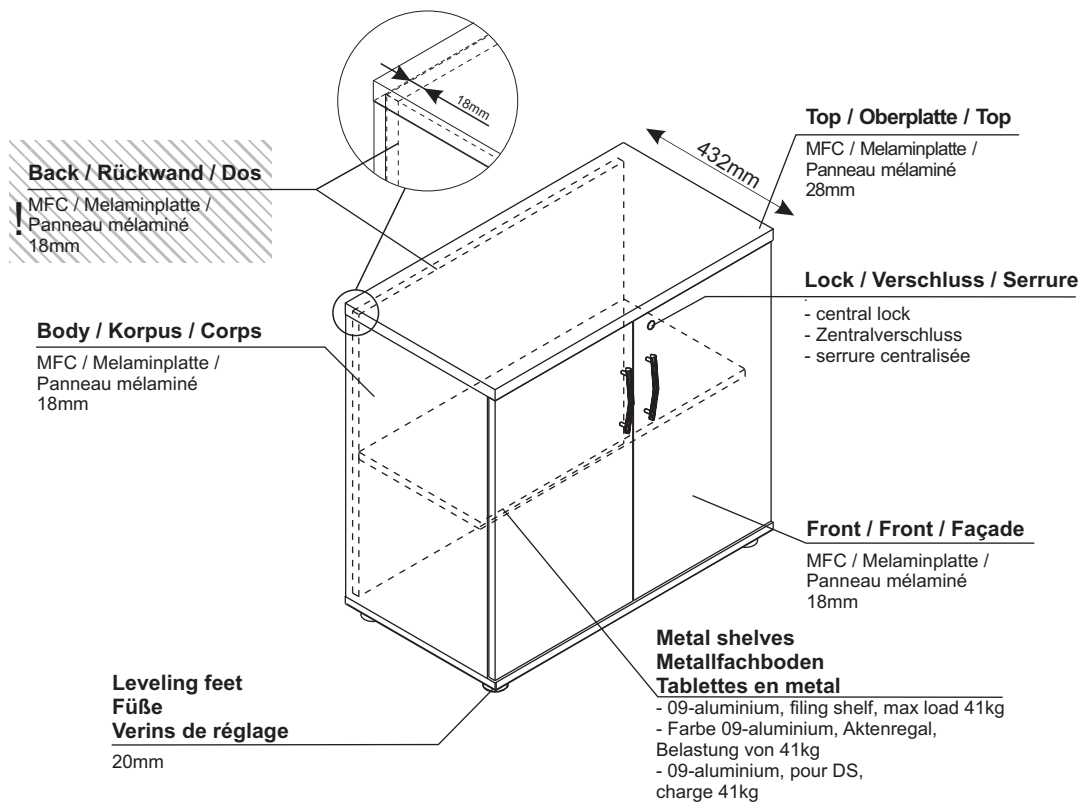

FINISHES / FARBEN / FINITIONS

Top, Bottom panel / Oberplatte, Sockel / Top, Plinthe

14-BEECH BUCHE HETRE	26-ALUMINUM SATINATO ALUMINIUM SATINATO ALUMINIUM SATINE	31-CANADIAN OAK KANADISCHE EICHE CHENE CANADIEN	34-CHESTNUT WENGE WENGE
39-POLAR BIRCH POLARBIERKE BOULEAU CLAIR	64-COCOA COCOA CACAO	67-WHITE PASTEL WEIß PASTELL BLANC PASTEL	106-LOWLAND NUT NUSSBAUM NOYER

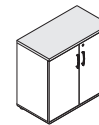
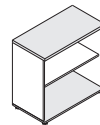

Front / Front / Façade

14-BEECH BUCHE HETRE	26-ALUMINUM SATINATO ALUMINIUM SATINATO ALUMINIUM SATINE	31-CANADIAN OAK KANADISCHE EICHE CHENE CANADIEN	34-CHESTNUT WENGE WENGE	39-POLAR BIRCH POLARBIERKE BOULEAU CLAIR	64-COCOA COCOA CACAO	67-WHITE PASTEL WEIß PASTELL BLANC PASTEL	106-LOWLAND NUT NUSSBAUM NOYER
----------------------------	--	---	-------------------------------	--	----------------------------	---	--------------------------------------

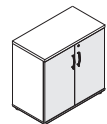

Body / Korpus / Corps

26-ALUMINUM SATINATO ALUMINIUM SATINATO ALUMINIUM SATINE	67-WHITE PASTEL WEIß PASTELL BLANC PASTEL
--	---

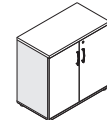
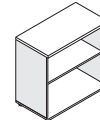

I - first group / I - erste Gruppe / I - première groupe de prix





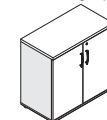
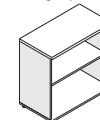

14-BEECH BUCHE HETRE	31-CANADIAN OAK KANADISCHE EICHE CHENE CANADIEN	34-CHESTNUT WENGE WENGE	39-POLAR BIRCH POLARBIERKE BOULEAU CLAIR	64-COCOA COCOA CACAO	106-LOWLAND NUT NUSSBAUM NOYER
----------------------------	---	-------------------------------	--	----------------------------	--------------------------------------

II - second group / II - zweite Gruppe / II - deuxième groupe de prix



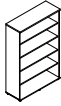
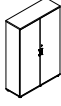

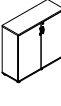
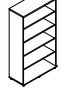
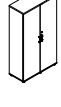
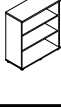
PRODUCT ILLUSTRATION / PRODUKTANSICHT UND SKIZZE / VUE DE PRODUIT	DIMENSIONS / ABMESSUNGEN [mm]			INDEX SYMBOL	PRICE EUR				ECO EUR	COMMENTS / BEMERKUNGEN / REMARQUES
	WIDTH / BREITE / LARGEUR	DEPTH / TIEFE / PROFONDEUR	HEIGHT / HÖHE / HAUTEUR			kg	m3	pcs		

STORAGEES WITH METAL SHELVES / SCHRÄNKE UND REGALE MIT METALLFACHBODEN / ARMOIRES AVEC TABLETTES EN METAL

	1200	432	1833	A5506TM		66.0	0.218	2	7.326	4 metal shelves / 4 Metallfächer / 4 tablettes en metal
	1200	432	1833	A5106TM		91.0	0.289	3	10.101	4 metal shelves / 4 Metallfächer / 4 tablettes en metal
	1200	432	1129	A3506TM		46.0	0.127	2	5.106	2 metal shelves / 2 Metallfächer / 2 tablettes en metal
	1200	432	1129	A3106TM		61.0	0.172	3	6.771	2 metal shelves / 2 Metallfächer / 2 tablettes en metal
	1000	432	1833	A5505TM		59.0	0.158	2	6.549	4 metal shelves / 4 Metallfächer / 4 tablettes en metal
	1000	432	1833	A5105TM		80.0	0.218	3	8.880	4 metal shelves / 4 Metallfächer / 4 tablettes en metal
	1000	432	1129	A3505TM		39.0	0.100	2	4.329	2 metal shelves / 2 Metallfächer / 2 tablettes en metal
	1000	432	1129	A3105TM		52.0	0.138	3	5.772	2 metal shelves / 2 Metallfächer / 2 tablettes en metal

ADDITIONAL CHARGE / AUFPREIS FÜR SONDERAUSSTATTUNG / PLUS VALUE



												
	A5506TM	A5106TM	A3506TM	A3106TM	A5505TM	A5105TM	A3505TM	A3105TM				
										0.0	0.0000	0
										1.0	0.0010	1

DESCRIPTION / LEGENDE / LÉGENDE:





 net weight / Nettogewicht / poids net

 volume / Volumen / le volume



 number of packages / Stückzahl der Pakete / nombre de colis

PRODUCT ILLUSTRATION / PRODUKTANSICHT UND SKIZZE / VUE DE PRODUIT	DIMENSIONS / ABMESSUNGEN [mm]			INDEX SYMBOL	PRICE EUR				ECO	COMMENTS / BEMERKUNGEN / REMARQUES
	WIDTH / BREITE / LARGEUR	DEPTH / TIEFE / PROFONDEUR	HEIGHT / HÖHE / HAUTEUR			kg	m3	pcs	EUR	

STORAGEES WITH METAL SHELVES / SCHRÄNKE UND REGALE MIT METALLFACHBODEN / ARMOIRES AVEC TABLETTES EN METAL

	801	432	1833	A5504TM		55.0	0.167	2	6.105	4 metal shelves / 4 Metallfächer / 4 tablettes en metal
	801	432	1833	A5104TM		72.0	0.215	3	7.992	4 metal shelves / 4 Metallfächer / 4 tablettes en metal
	801	432	1129	A3504TM		36.0	0.091	2	3.996	2 metal shelves / 2 Metallfächer / 2 tablettes en metal
	801	432	1129	A3104TM		47.3	0.118	3	5.250	3 metal shelves / 2 Metallfächer / 2 tablettes en metal

ADDITIONAL CHARGE / AUFPREIS FÜR SONDERAUSSTATTUNG / PLUS VALUE

									
	A5504TM	A5104TM	A3504TM	A3104TM					
						0.0	0.0000	0	
						1.0	0.0010	1	

DESCRIPTION / LEGENDE / LÉGENDE:

 net weight / Nettogewicht / poids net

 volume / Volumen / le volume

 number of packages / Stückzahl der Pakete / nombre de colis



**PEDESTAL / CONTAINER / CAISSON
SLD13HT / SLD12HT**

Top / Oberplatte / Top

HPL / HPL / stratifié

Body / Korpus / Corps

MFC / Melaminplatte /
Panneau mélaminé
18mm

**Metal drawers
Metallschubladen
Tiroirs en metal**

- self closing system as an option
roll runners with 25 kg maximum
acceptable load . Extraction 80%.
- Leises Selbstschließsystem als Option
Rollenführungsschiene mit einer Belastung
von max. 25kg. 80% Auszug.
- Glissieres a galets, fermeture silencieuse en option,
Glissieres a billes en option. Charge jusqu 'a 25 kg.
Extraction 80%.

- central lock with antitilt mechanism (only one
drawermay be opened at time), foldable key.
- Zentralverschluss mit Blockierung gegen das gleichzeitige
Ausfahren von mehreren Schubladen, Klappschlüssel
- clé gainée articulée, serrure centralisée, assure la fermeture
de l'ensemble des tiroirs

Front / Front / Façade

HPL / HPL / stratifié

Extraction 80%
80% Auszug
Extraction 80%

Casters/ Rollen / Roulettes

- two of them with brakes
- Bremsrollen vorne
- dont deux équipés de freins
ø50mm

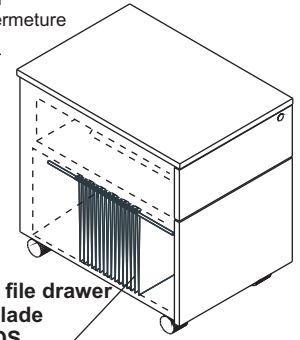
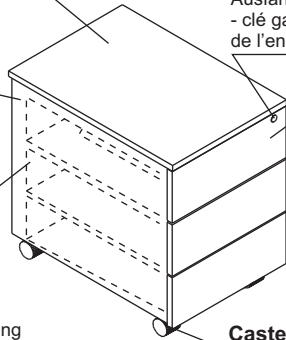

**Suspension file drawer
Aktenschublade
Tiroir pour DS.**

Extraction 100%
100% Auszug
Extraction 100%





FINISHES / FARBEN / FINITIONS



08-BLACK SCHWARZ NOIR	101- HIGH GLOSS BLACK SCHWARZ GLANZ NOIR BRILLANT		
67-WHITE PASTEL WEIß PASTELL BLANC PASTEL	73-HIGH GLOSS WHITE WEIß GLANZ BLANC BRILLANT		

PRODUCT ILLUSTRATION / PRODUKTANSICHT UND SKIZZE / VUE DE PRODUIT	DIMENSIONS / ABMESSUNGEN [mm]			INDEX SYMBOL	PRICE EUR				ECO	COMMENTS / BEMERKUNGEN / REMARQUES
	WIDTH / BREITE / LARGEUR	DEPTH / TIEFE / PROFONDEUR	HEIGHT / HÖHE / HAUTEUR			kg	m3	pcs	EUR	

HPL PEDESTAL / ROLLCONTAINER MIT OBERKRANZ UND HPL-FRONT / CAISSONS STRATIFIÉ

	416	600	587	SLD12HT		23.0	0.158	1	2.553	
	416	600	587	SLD13HT		23.0	0.158	1	2.553	

ADDITIONAL CHARGE / AUFPREIS FÜR SONDERAUSSTATTUNG / PLUS VALUE

													
SLD12HT	SLD13HT												
										1.0	0.0010	1	
										1.0	0.0010	1	

DESCRIPTION / LEGENDE / LÉGENDE:

 net weight / Nettogewicht / poids net

 volume / Volumen / le volume

 number of packages / Stückzahl der Pakete / nombre de colis



STORAGES / SCHRÄNKE / RANGEMENTS

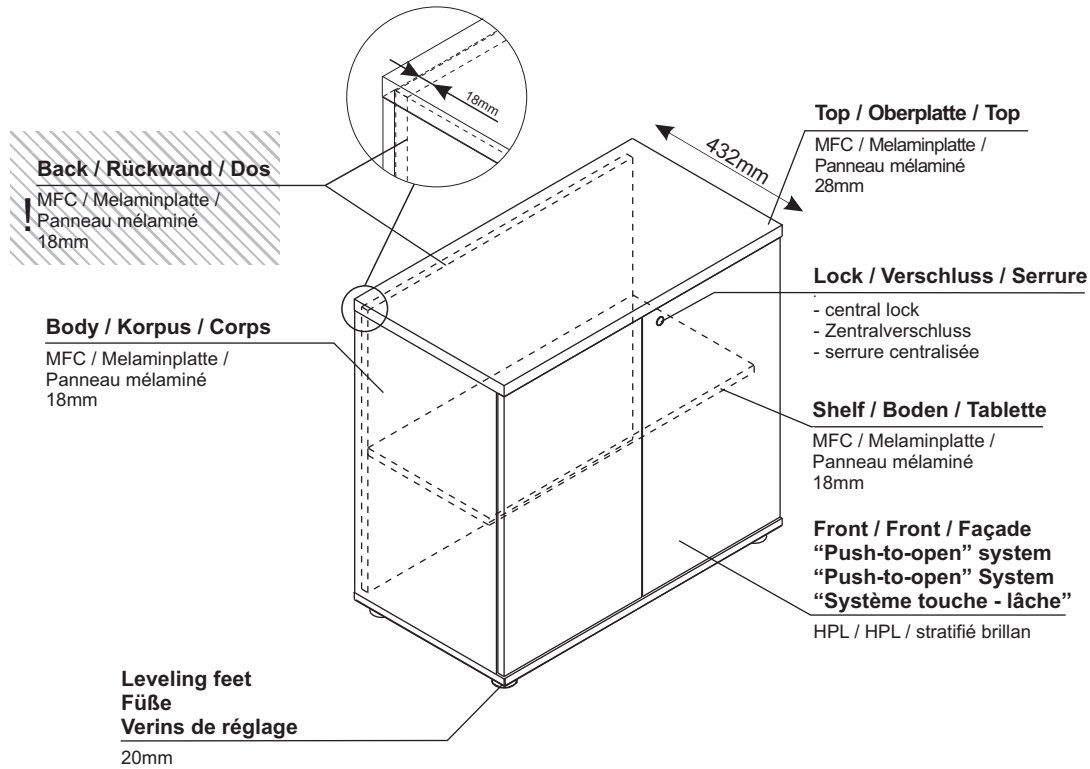

A..HGZ

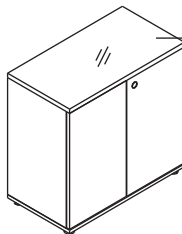

Glass top (optional)
Obepatte aus Glas (Optional)
Top en verre (optionnel)

MFC + glass: LACOBEL /
Melaminplatte + Glas: LACOBEL /
Panneau mélaminé + verre: LACOBEL
28mm+4mm

A5404WZ

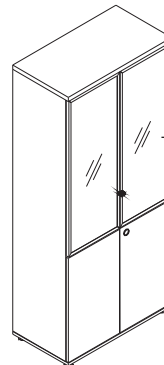

Front / Front / Façade

doors with transparent tempered glass and aluminum frame.
Aluminiumrahmen, Klarhartglas.
verre trempé, cadre en aluminium

FINISHES / FARBEN / FINITIONS

Front / Front / Façade



72-HIGH GLOSS LIME GRÜN GLANZ VERT BRILLANT	73-HIGH GLOSS WHITE WEIß GLANZ BLANC BRILLANT	74-HIGH GLOSS ORANGE ORANGE GLANZ ORANGE BRILLANT	82-HIGH GLOSS RED ROT GLANZ ROUGE BRILLANT	101- HIGH GLOSS BLACK SCHWARZ GLANZ NOIR BRILLANT	A...H	A...HG	A5404W
					doors with transparent tempered glass and aluminum frame. Aluminiumrahmen, Klarhartglas. verre trempé, cadre en aluminium		

Body, Top, Bottom panel / Korpus, Oberplatte, Sockel / Corps, Top, Plinthe





08-BLACK SCHWARZ NOIR	67-WHITE PASTEL WEIß PASTELL BLANC PASTEL	A...HZ	A5404WZ
		doors with transparent tempered glass and aluminum frame. Aluminiumrahmen, Klarhartglas. verre trempé, cadre en aluminium	

Glass top / Obepatte aus Glas / Top en verre

08-BLACK SCHWARZ NOIR	116-BLACK GLASS SCHWARZ GLAS NOIR VERRE	A...HGZ	
67-WHITE PASTEL WEIß PASTELL BLANC PASTEL	117-WHITE GLASS WEIß GLAS BLANC VERRE	A...HGZ	

PRODUCT ILLUSTRATION / PRODUKTANSICHT UND SKIZZE / VUE DE PRODUIT	DIMENSIONS / ABMESSUNGEN [mm]			INDEX SYMBOL	PRICE EUR				ECO EUR	COMMENTS / BEMERKUNGEN / REMARQUES
	WIDTH / BREITE / LARGEUR	DEPTH / TIEFE / PROFONDEUR	HEIGHT / HÖHE / HAUTEUR			kg	m3	pcs		

STORAGES WITH HPL FRONT / SCHRÄNKE MIT HPL-FRONT / ARMOIRES AVEC DES FAÇADES EN STRATIFIÉ



	801	432	1833	A5104HZ		75.0	0.215	3	8.325	
	801	432	1833	A5404HZ		65.0	0.189	3	7.215	
	801	432	1129	A3104HZ		44.0	0.120	3	4.884	
	801	432	1129	A3404HZ		40.0	0.111	3	4.440	
	801	432	777	A2104HZ		35.0	0.092	3	3.885	

DESCRIPTION / LEGENDE / LÉGENDE:







 net weight / Nettogewicht / poids net

 volume / Volumen / le volume

 number of packages / Stückzahl der Pakete / nombre de colis

PRODUCT ILLUSTRATION / PRODUKTANSICHT UND SKIZZE / VUE DE PRODUIT	DIMENSIONS / ABMESSUNGEN [mm]			INDEX SYMBOL	PRICE EUR				ECO EUR	COMMENTS / BEMERKUNGEN / REMARQUES
	WIDTH / BREITE / LARGEUR	DEPTH / TIEFE / PROFONDEUR	HEIGHT / HÖHE / HAUTEUR			kg	m3	pcs		

STORAGEES WITH HPL FRONT / SCHRÄNKE MIT HPL FRONT UND VERGLASUNG IM OBERKRANZ / ARMOIRES AVEC DES FAÇADES EN STRATIFIÉ

	801	432	1134	A3104HGZ		45.0	0.122	3	4.995	
	801	432	1134	A3404HGZ		41.0	0.113	3	4.551	
	801	432	782	A2104HGZ		36.0	0.094	3	3.996	
	801	432	1134	A3504G		34.0	0.091	2	3.774	
	801	432	782	A2504G		29.0	0.073	2	3.219	
	800	432	33	A800GT		8.0	0.017	1	0.888	top glass + mfc / oberes Glas + Melaminplatte / top en verre + panneau melamine

STORAGEES WITH GLASS DOORS / VITRINEN / ARMOIRES AVEC DES FAÇADES EN VERRE

	801	432	1833	A5404WZ		75.0	0.227	4	8.325	glass door in aluminum frame, hpl door / Glastür im Aluminiumrahmen, Sperrholz-Tür mit HPL-Front / porte vitrée, cadre en Aluminium - porte panneau avec la façade en stratifié
---	-----	-----	------	----------------	--	------	-------	---	-------	--

DESCRIPTION / LEGENDE / LÉGENDE:

 net weight / Nettogewicht / poids net

 volume / Volumen / le volume

 number of packages / Stückzahl der Pakete / nombre de colis

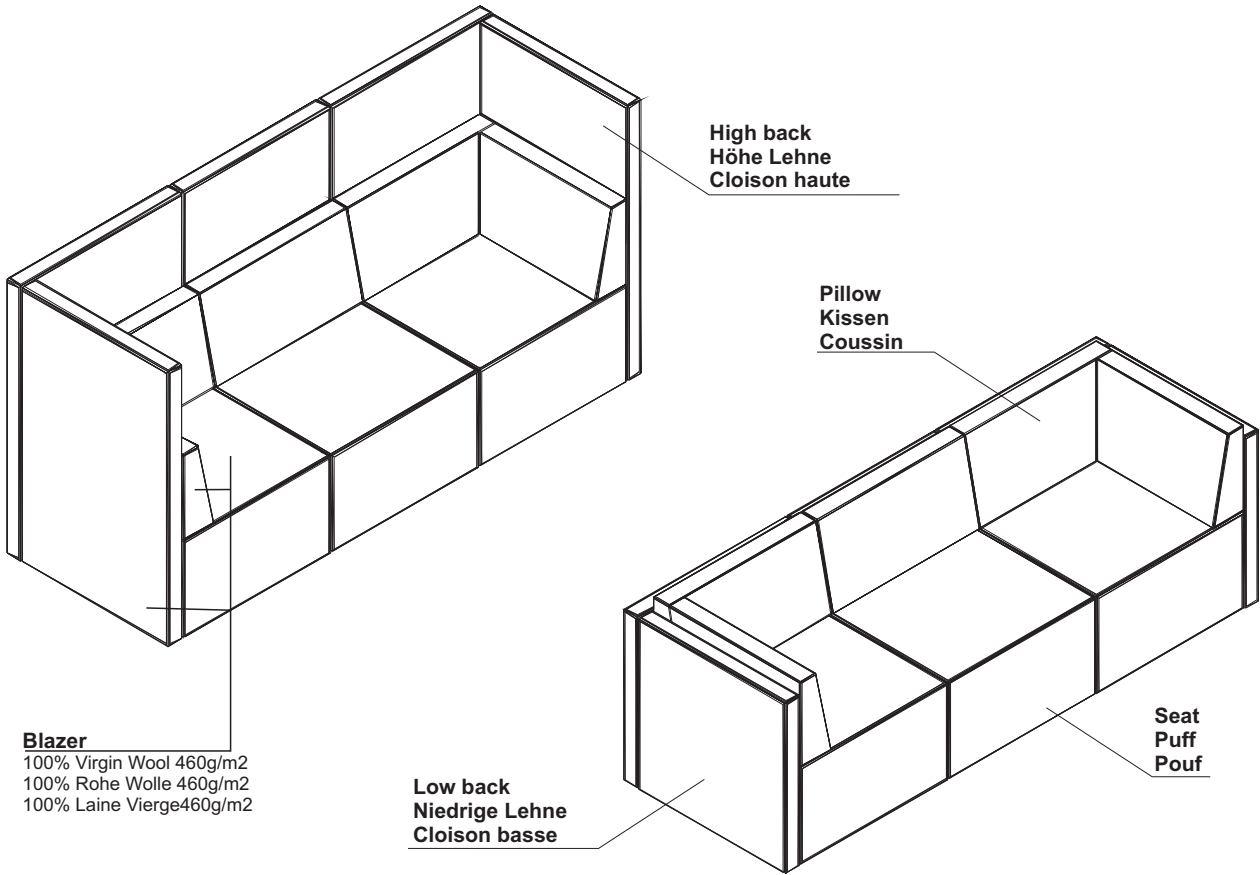

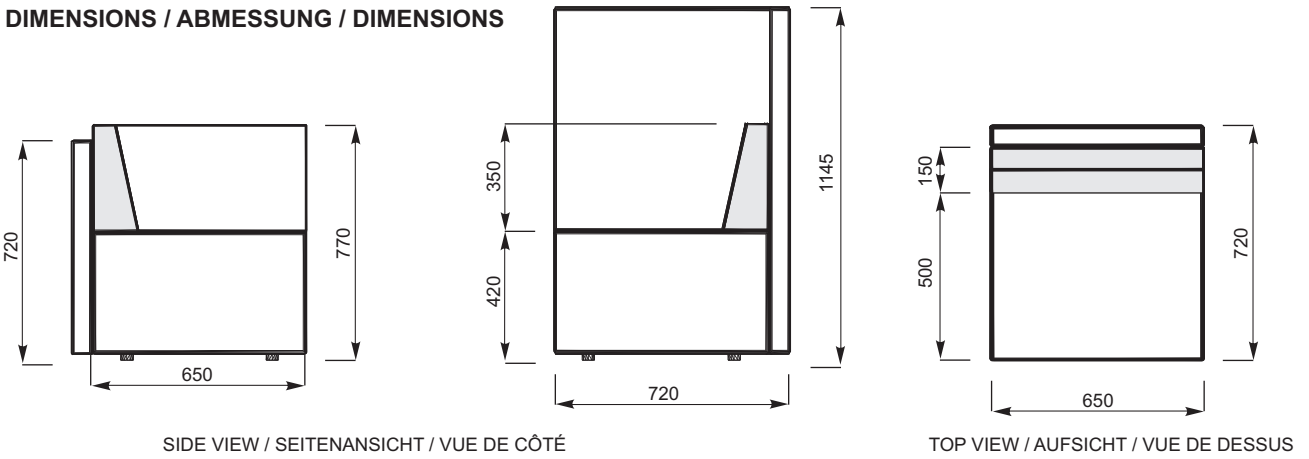

Blazer
100% Virgin Wool 460g/m2
100% Rohe Wolle 460g/m2
100% Laine Vierge 460g/m2

DIMENSIONS / ABMESSUNG / DIMENSIONS



FINISHES / FARBEN / FINITIONS



<p>ORANGE ORANGE ORANGE</p> <p>RED ROT ROUGE</p> <p>GREEN GRÜN VERT</p> <p>VIOLET VIOLETT VIOLET</p> <p>GREY GRAU GRIS</p>	<p>PILLOW / KISSEN / COUSSIN</p>
<p>GREY GRAU GRIS</p>	<p>BACK - LOW AND HIGH / NIEDRIGE UND HOHE LEHNE / CLOISON BASSE, HAUTE</p>
<p>GREY GRAU GRIS</p>	<p>SEAT / PUFF / POUF</p>

PRODUCT ILLUSTRATION / PRODUKTANSICHT UND SKIZZE / VUE DE PRODUIT	DIMENSIONS / ABMESSUNGEN [mm]			INDEX SYMBOL	PRICE EUR				ECO	COMMENTS / BEMERKUNGEN / REMARQUES
	WIDTH / BREITE / LARGEUR	DEPTH / TIEFE / PROFONDEUR	HEIGHT / HÖHE / HAUTEUR			kg	m3	pcs	EUR	

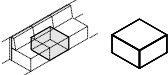

SEAT / PUFF / POUF

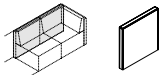
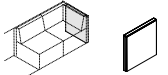
	650	650	420	MM-PU		17.0	0.177	1	2.091	
---	-----	-----	-----	--------------	--	------	-------	---	-------	--

LOW BACK / NIEDRIGE LEHNE / CLOISON BASSE

	650	70	700	MM-ON		8.1	0.032	1	0.996	
	720	70	700	MM-ONP		9.7	0.035	1	1.193	right / Rechts / droit
	720	70	700	MM-ONL		9.7	0.035	1	1.193	left / Links / gauche

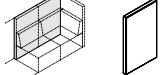
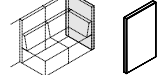
HIGH BACK / HÖHE LEHNE / CLOISON HAUTE



	650	70	1145	MM-OW		12.8	0.052	1	1.574	
	720	70	1145	MM-OWP		15.2	0.058	1	1.870	right / Rechts / droit
	720	70	1145	MM-OWL		15.2	0.058	1	1.870	left / Links / gauche

DESCRIPTION / LEGENDE / LÉGENDE:

 net weight / Nettogewicht / poids net

 volume / Volumen / le volume

 number of packages / Stückzahl der Pakete / nombre de colis

PRODUCT ILLUSTRATION / PRODUKTANSICHT UND SKIZZE / VUE DE PRODUIT	DIMENSIONS / ABMESSUNGEN [mm]			INDEX SYMBOL	PRICE EUR				ECO	COMMENTS / BEMERKUNGEN / REMARQUES
	WIDTH / BREITE / LARGEUR	DEPTH / TIEFE / PROFONDEUR	HEIGHT / HÖHE / HAUTEUR			kg	m3	pcs	EUR	

PILLOW / KISSEN / COUSSIN

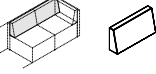
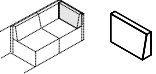
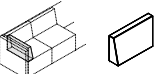
	650	150	350	MM-PO		1.9	0.034	1	0.234	
	574	150	350	MM-PP		1.9	0.030	1	0.234	right / Rechts / droit
	574	150	350	MM-PL		1.9	0.030	1	0.234	left / Links / gauche

DESCRIPTION / LEGENDE / LÉGENDE:

 net weight / Nettogewicht / poids net

 volume / Volumen / le volume

 number of packages / Stückzahl der Pakete / nombre de colis

CONFIGURATIONS / BEISPIEL ANORDNUNG

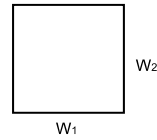
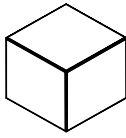

INDEX SYMBOL	DIMENSIONS / ABMESSUNGEN [mm]					EUR				ECO	COMMENTS / BEMERKUNGEN / REMARQUES
	W ₁	W ₂	D ₁	D ₂	H		kg	m ³	pcs	EUR	
MM-PM	450	450	-	-	420		14.0	0.085	1	1.722	

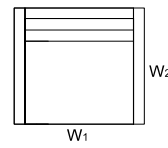
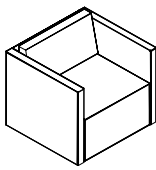

MM-PU + MM-ON + MM-ONP + MM-ONL + MM-PO

INDEX SYMBOL	DIMENSIONS / ABMESSUNGEN [mm]					EUR				ECO	COMMENTS / BEMERKUNGEN / REMARQUES
	W ₁	W ₂	D ₁	D ₂	H		kg	m ³	pcs	EUR	
MM-1N	790	720	-	-	770		46.4	0.314	5	5.707	

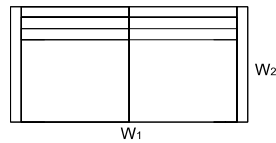
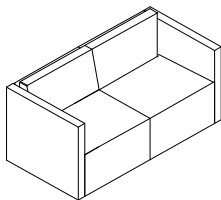

3xMM-PU + 3xMM-ON + 3xMM-PO + MM-ONP + MM-ONL

INDEX SYMBOL	DIMENSIONS / ABMESSUNGEN [mm]					EUR				ECO	COMMENTS / BEMERKUNGEN / REMARQUES
	W ₁	W ₂	D ₁	D ₂	H		kg	m ³	pcs	EUR	
MM-2N	1440	720	-	-	770		46.4	0.314	8	5.707	

DESCRIPTION / LEGENDE / LÉGENDE:

net weight / Nettogewicht / poids net

volume / Volumen / le volume

number of packages / Stückzahl der Pakete / nombre de colis

CONFIGURATIONS / BEISPIEL ANORDNUNG

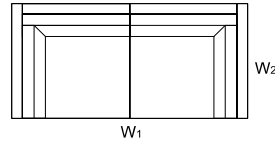
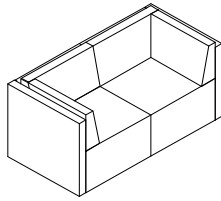

2xMM-PU + 2xMM-ON + 2xMM-PO + MM-ONP + MM-ONL + MM-PP + MM-PL

INDEX SYMBOL	DIMENSIONS / ABMESSUNGEN [mm]					EUR				ECO	COMMENTS / BEMERKUNGEN / REMARQUES
	W ₁	W ₂	D ₁	D ₂	H		kg	m ³	pcs	EUR	
MM-2NP	1440	720	-	-	770		50.2	0.374	10	6.175	

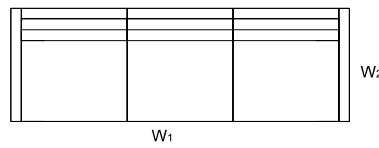
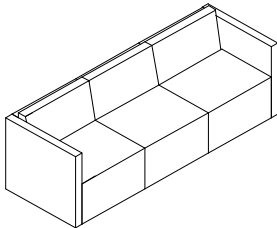

3xMM-PU + 3xMM-ON + 3xMM-PO + MM-ONP + MM-ONL

INDEX SYMBOL	DIMENSIONS / ABMESSUNGEN [mm]					EUR				ECO	COMMENTS / BEMERKUNGEN / REMARQUES
	W ₁	W ₂	D ₁	D ₂	H		kg	m ³	pcs	EUR	
MM-3N	2090	720	-	-	770		46.4	0.314	11	5.707	

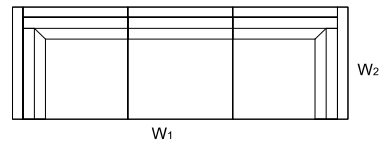
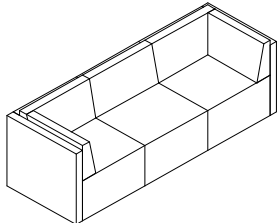

3xMM-PU + 3xMM-ON + 3xMM-PO + MM-ONP + MM-ONL + MM-PP + MM-PL

INDEX SYMBOL	DIMENSIONS / ABMESSUNGEN [mm]					EUR				ECO	COMMENTS / BEMERKUNGEN / REMARQUES
	W ₁	W ₂	D ₁	D ₂	H		kg	m ³	pcs	EUR	
MM-3NP	2090	720	-	-	770		50.2	0.374	13	6.175	

DESCRIPTION / LEGENDE / LÉGENDE:

net weight / Nettogewicht / poids net

volume / Volumen / le volume

number of packages / Stückzahl der Pakete / nombre de colis

CONFIGURATIONS / BEISPIEL ANORDNUNG

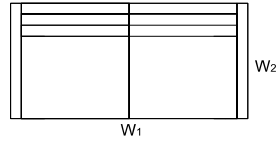
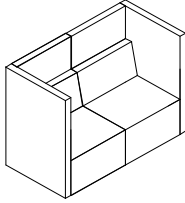

2xMM-PU + 2xMM-OW + 2xMM-PO + MM-OWP + MM-OWL

INDEX SYMBOL	DIMENSIONS / ABMESSUNGEN [mm]					EUR				ECO	COMMENTS / BEMERKUNGEN / REMARQUES
	W ₁	W ₂	D ₁	D ₂	H		kg	m ³	pcs	EUR	
MM-2W	1140	720	-	-	1145		62.1	0.379	8	7.638	

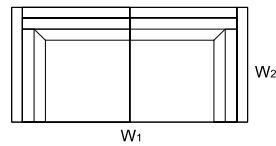
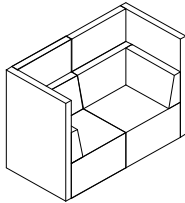

2xMM-PU + 2xMM-OW + 2xMM-PO + MM-OWP + MM-OWL + MM-PP + MM-PL

INDEX SYMBOL	DIMENSIONS / ABMESSUNGEN [mm]					EUR				ECO	COMMENTS / BEMERKUNGEN / REMARQUES
	W ₁	W ₂	D ₁	D ₂	H		kg	m ³	pcs	EUR	
MM-2WP	1140	720	-	-	1145		65.9	0.439	10	8.106	

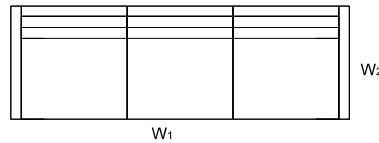
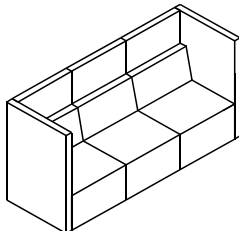

3xMM-PU + 3xMM-OW + 3xMM-PO + MM-OWP + MM-OWL

INDEX SYMBOL	DIMENSIONS / ABMESSUNGEN [mm]					EUR				ECO	COMMENTS / BEMERKUNGEN / REMARQUES
	W ₁	W ₂	D ₁	D ₂	H		kg	m ³	pcs	EUR	
MM-3W	2090	720	-	-	1145		62.1	0.379		71638	

DESCRIPTION / LEGENDE / LÉGENDE:

net weight / Nettogewicht / poids net

volume / Volumen / le volume

number of packages / Stückzahl der Pakete / nombre de colis

CONFIGURATIONS / BEISPIEL ANORDNUNG

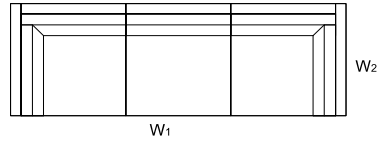
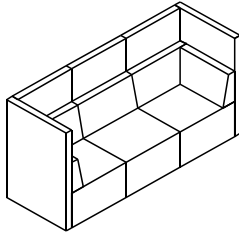

3XMM-PU + 3XMM-OW + 3XMM-PO + MM-OWP + MM-OWL + MM-PP + MM-PL

INDEX SYMBOL	DIMENSIONS / ABMESSUNGEN [mm]					EUR				ECO	COMMENTS / BEMERKUNGEN / REMARQUES
	W ₁	W ₂	D ₁	D ₂	H		kg	m ³	pcs	EUR	
MM-3WP	2090	720	-	-	1145		65.9	0.439	13	8.106	

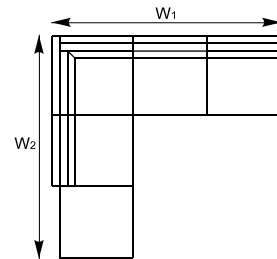
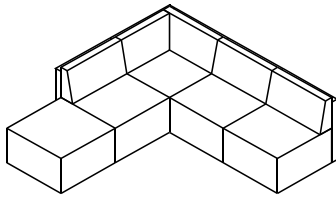

5xMM-PU + 3xMMPO + 3xMM-ON + MM-ONP + MM-ONL + MM-PL + MM-PP

INDEX SYMBOL	DIMENSIONS / ABMESSUNGEN [mm]					EUR				ECO	COMMENTS / BEMERKUNGEN / REMARQUES
	W ₁	W ₂	D ₁	D ₂	H		kg	m ³	pcs	EUR	
MM-U01	2020	2020	-	-	770		38.6	0.309	15	4.748	

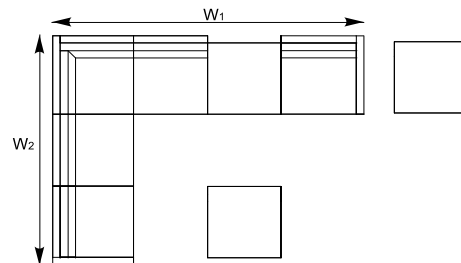
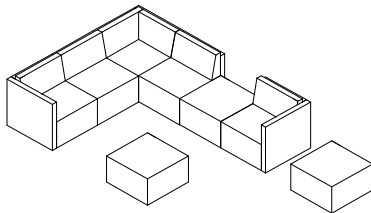

8xMM-PU + MM-ONP + 2xMM-ONL + 5xMM-ON + 5xMM-PO + MM-PL

INDEX SYMBOL	DIMENSIONS / ABMESSUNGEN [mm]					EUR				ECO	COMMENTS / BEMERKUNGEN / REMARQUES
	W ₁	W ₂	D ₁	D ₂	H		kg	m ³	pcs	EUR	
MM-U02	2740	2090	-	-	770		48.3	0.344	22	5.941	

DESCRIPTION / LEGENDE / LÉGENDE:

net weight / Nettogewicht / poids net

volume / Volumen / le volume

number of packages / Stückzahl der Pakete / nombre de colis

CONFIGURATIONS / BEISPIEL ANORDNUNG

MM-1N + MM-3NP + 4xMM-PU + MM-ONL + MM-ON + MM-PO

INDEX SYMBOL	DIMENSIONS / ABMESSUNGEN [mm]					EUR				ECO	COMMENTS / BEMERKUNGEN / REMARQUES
	W ₁	W ₂	D ₁	D ₂	H		kg	m ³	pcs	EUR	
MM-U03	3590	2390	-	-	770		50.2	0.374	25	6.175	

2xMM-3WP + 2xMM-PU

INDEX SYMBOL	DIMENSIONS / ABMESSUNGEN [mm]					EUR				ECO	COMMENTS / BEMERKUNGEN / REMARQUES
	W ₁	W ₂	D ₁	D ₂	H		kg	m ³	pcs	EUR	
MM-U04	3140	3140	-	-	1145		65.9	0.439	28	8.106	

6xMM-PU + 2xMM-ONP + 4xMM-ON + 4xMM-PO + MM-PL

INDEX SYMBOL	DIMENSIONS / ABMESSUNGEN [mm]					EUR				ECO	COMMENTS / BEMERKUNGEN / REMARQUES
	W ₁	W ₂	D ₁	D ₂	H		kg	m ³	pcs	EUR	
MM-U05	2090	2020	-	-	770		48.3	0.344	17	5.941	

DESCRIPTION / LEGENDE / LÉGENDE:

net weight / Nettogewicht / poids net

volume / Volumen / le volume

number of packages / Stückzahl der Pakete / nombre de colis

CONFIGURATIONS / BEISPIEL ANORDNUNG

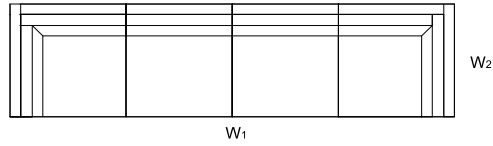
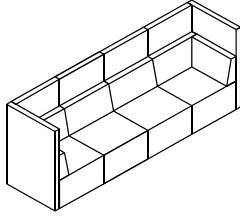

4xMM-PU + 4xMM-OW + 4xMM-PO + MM-PP + MMPL + MM-OWP + MM-OWL

INDEX SYMBOL	DIMENSIONS / ABMESSUNGEN [mm]					EUR				ECO	COMMENTS / BEMERKUNGEN / REMARQUES
	W ₁	W ₂	D ₁	D ₂	H		kg	m ³	pcs	EUR	
MM-U06	2740	2390	-	-	1145		65.9	0.439	16	8.106	

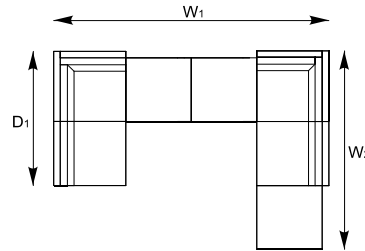
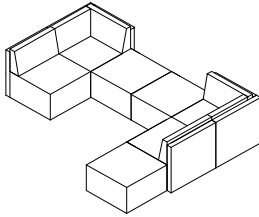

7xMM-PU + 4xMM-ON + 2xMM-ONP + 4xMM-PO + MM-PP + MM-PL

INDEX SYMBOL	DIMENSIONS / ABMESSUNGEN [mm]					EUR				ECO	COMMENTS / BEMERKUNGEN / REMARQUES
	W ₁	W ₂	D ₁	D ₂	H		kg	m ³	pcs	EUR	
MM-U07	2740	2020	-	-	770		50.2	0.374	19	6.175	

DESCRIPTION / LEGENDE / LÉGENDE:

net weight / Nettogewicht / poids net

volume / Volumen / le volume

number of packages / Stückzahl der Pakete / nombre de colis

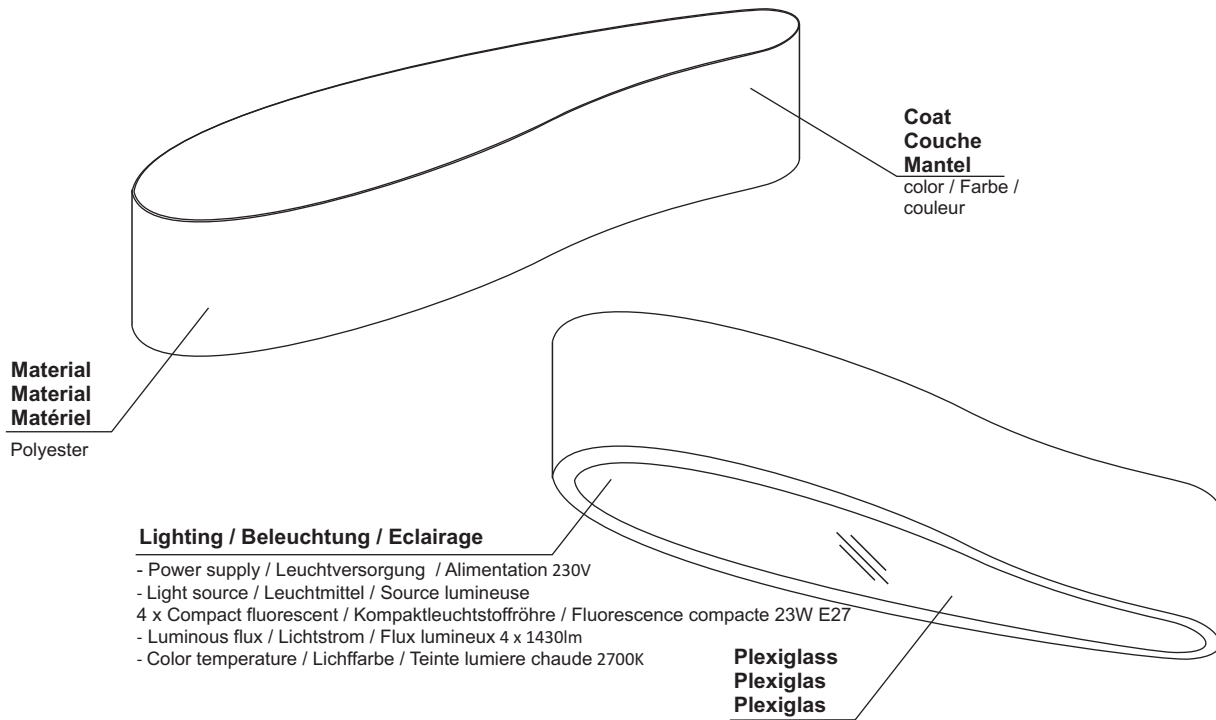

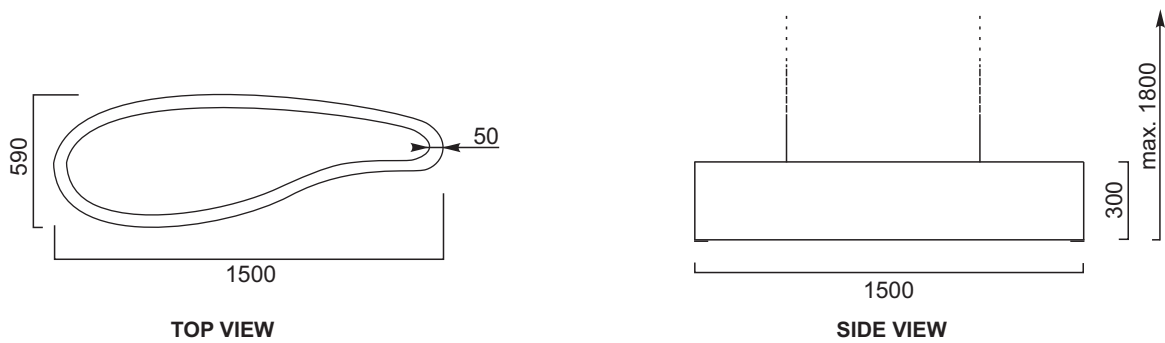

(1 year warranty / 1 Jahr Garantie / garantie 1an)



FINISHES / FARBEN / FINITIONS



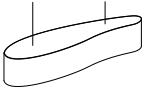

PRODUCT ILLUSTRATION / PRODUKTANSICHT UND SKIZZE / VUE DE PRODUIT	DIMENSIONS / ABMESSUNGEN [mm]			INDEX SYMBOL	PRICE EUR				ECO	COMMENTS / BEMERKUNGEN / REMARQUES
	WIDTH / BREITE / LARGEUR	DEPTH / TIEFE / PROFONDEUR	HEIGHT / HÖHE / HAUTEUR			kg	m3	pcs	EUR	

LAMP / LAMPE

	1500	590	300	SSL15		16.0	0.266	1	1.968	
---	------	-----	-----	--------------	--	------	-------	---	-------	--

DESCRIPTION / LEGENDE / LÉGENDE:

 net weight / Nettogewicht / poids net

 volume / Volumen / le volume

 number of packages / Stückzahl der Pakete / nombre de colis

Material
Material
Matériel
Polyester

Coat
Couche
Mantel

color / Farbe /
couleur

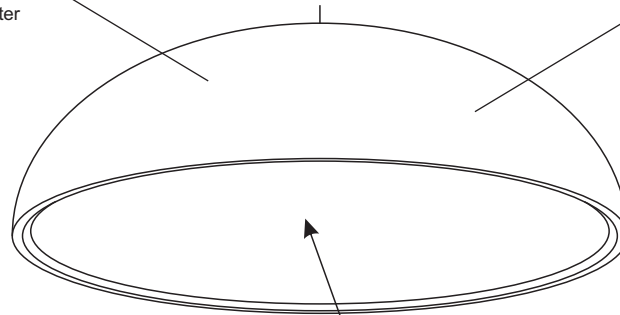

Lighting / Beleuchtung / Eclairage

- Power supply / Leuchtversorgung / Alimentation 230V
- Light source / Leuchtmittel / Source lumineuse
1 x Compact fluorescent / Kompaktleuchtstoffröhre / Fluorescence compacte 42W E27
- Strumień światły 3100lm
- Color temperature / Lichffarbe / Teinte lumiere chaude 2700K

(1 year warranty / 1 Jahr Garantie / garantie 1an)

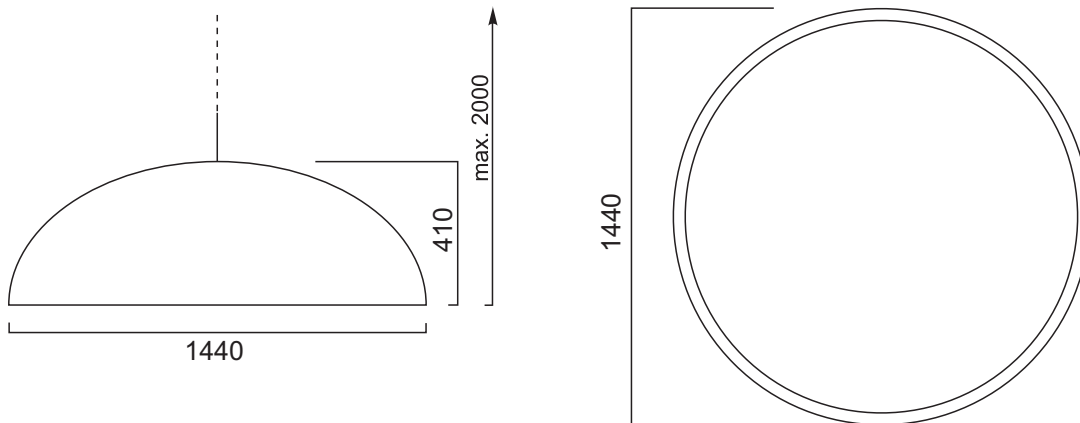

FINISHES / FARBEN / FINITIONS

WHITE, GLOSS
WEISS, GLANZ
BLANC, BRILLANT

BLACK, GLOSS
SCHWARZ, GLANZ
NOIR, BRILLANT

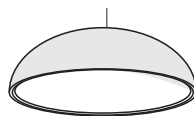



LAMP SUNBEAM / LAMPE SUNBEAM

PRODUCT ILLUSTRATION / PRODUKTANSICHT UND SKIZZE / VUE DE PRODUIT	DIMENSIONS / ABMESSUNGEN [mm]			INDEX SYMBOL	PRICE EUR				ECO	COMMENTS / BEMERKUNGEN / REMARQUES
	WIDTH / BREITE / LARGEUR	DEPTH / TIEFE / PROFONDEUR	HEIGHT / HÖHE / HAUTEUR			kg	m3	pcs	EUR	

LAMP / LAMPE

	1440	1440	410	SNL16		0.0	0.000	1	0.000	
--	------	------	-----	--------------	--	-----	-------	---	-------	--

DESCRIPTION / LEGENDE / LÉGENDE:

net weight / Nettogewicht / poids net

volume / Volumen / le volume

number of packages / Stückzahl der Pakete / nombre de colis

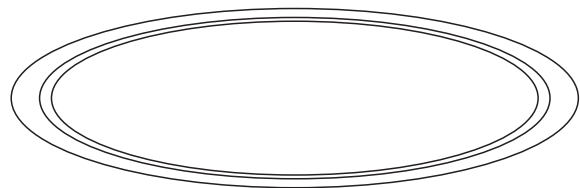
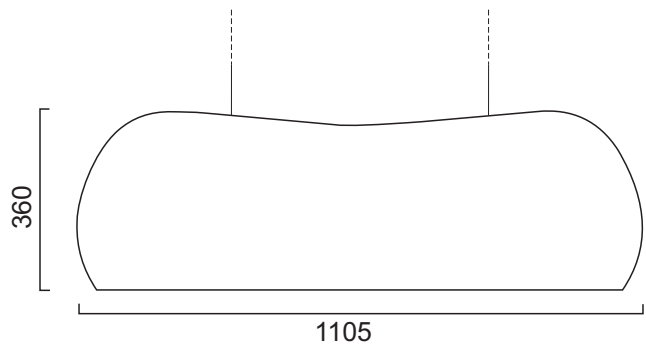
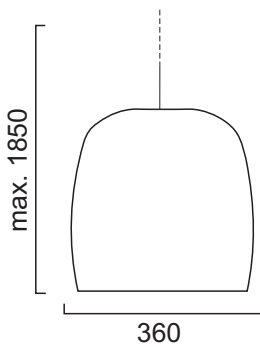
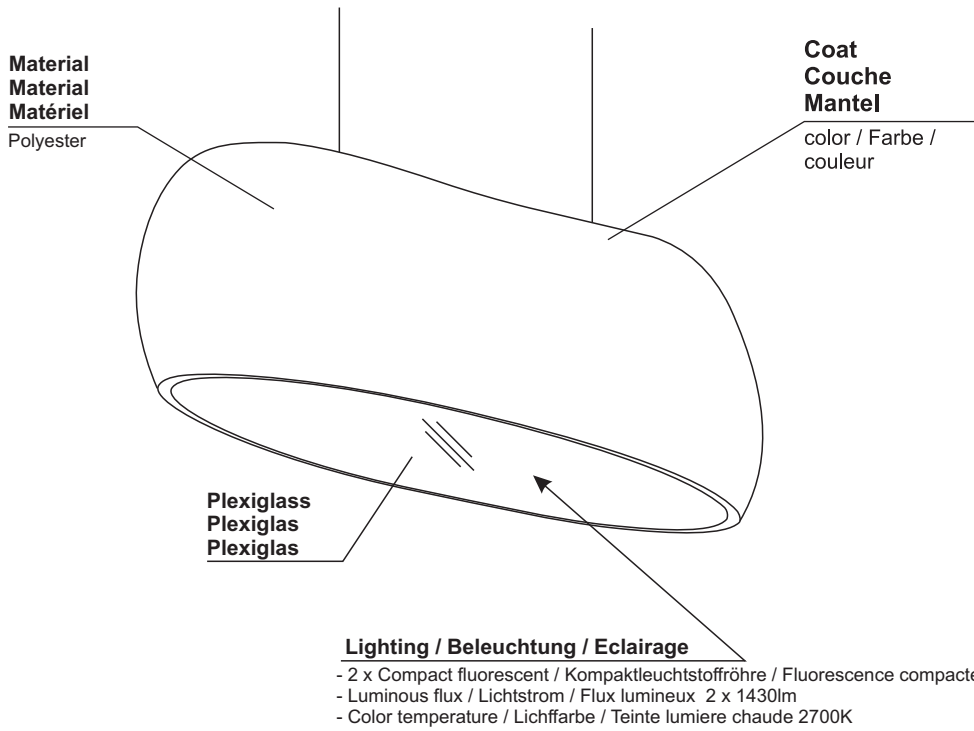

FINISHES / FARBEN / FINITIONS

WHITE, GLOSS
WEIß, GLANZ
BLANC, BRILLANT

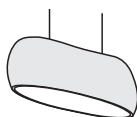



LAMP CANOE / LAMPE CANOE

PRODUCT ILLUSTRATION / PRODUKTANSICHT UND SKIZZE / VUE DE PRODUIT	DIMENSIONS / ABMESSUNGEN [mm]			INDEX SYMBOL	PRICE EUR				ECO	COMMENTS / BEMERKUNGEN / REMARQUES
	WIDTH / BREITE / LARGEUR	DEPTH / TIEFE / PROFONDEUR	HEIGHT / HÖHE / HAUTEUR			kg	m3	pcs	EUR	

LAMP / LAMPE

	1105	360	360	CAN11		12.0	0.169	1	1.476	
--	------	-----	-----	--------------	--	------	-------	---	-------	--

DESCRIPTION / LEGENDE / LÉGENDE:

net weight / Nettogewicht / poids net

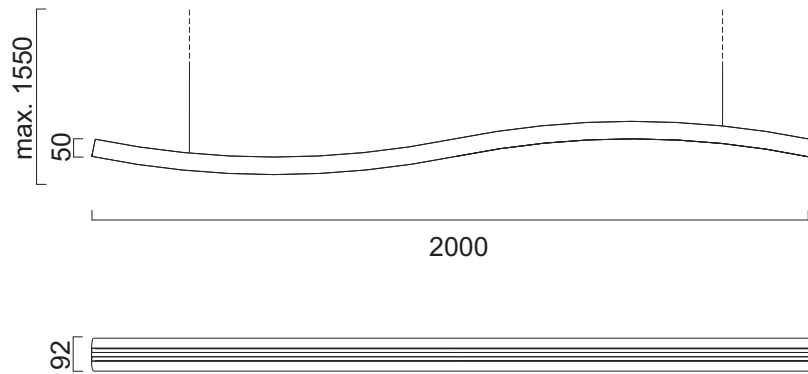
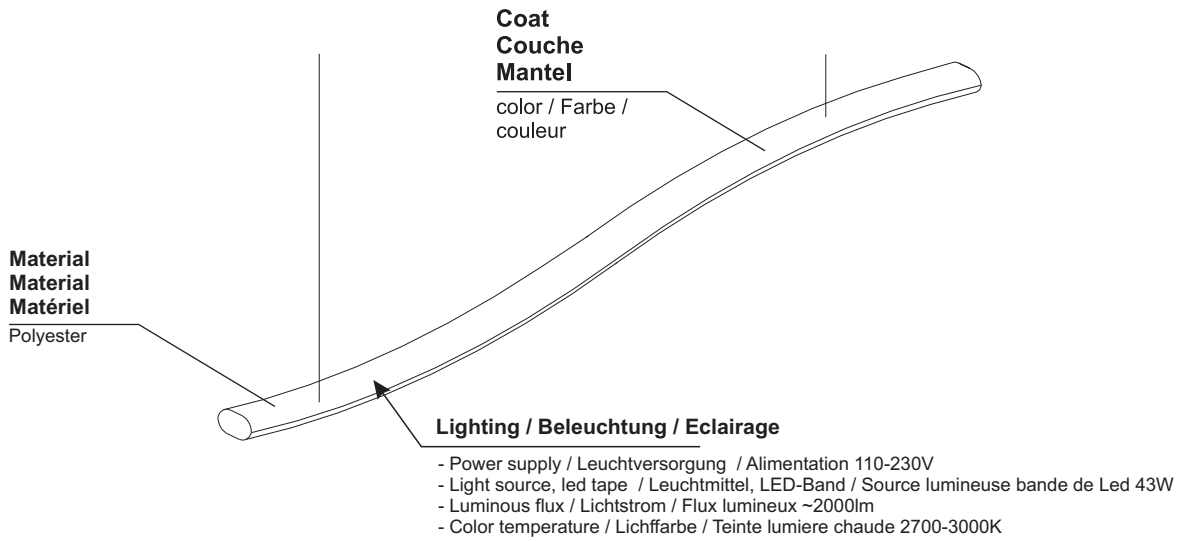

volume / Volumen / le volume

number of packages / Stückzahl der Pakete / nombre de colis



FINISHES / FARBEN / FINITIONS

<p>WHITE, GLOSS WEIß, GLANZ BLANC, BRILLANT</p>	
---	--

PRODUCT ILLUSTRATION / PRODUKTANSICHT UND SKIZZE / VUE DE PRODUIT	DIMENSIONS / ABMESSUNGEN [mm]			INDEX SYMBOL	PRICE EUR				ECO	COMMENTS / BEMERKUNGEN / REMARQUES
	WIDTH / BREITE / LARGEUR	DEPTH / TIEFE / PROFONDEUR	HEIGHT / HÖHE / HAUTEUR			kg	m3	pcs	EUR	

LAMP / LAMPE

	2000	90	150	SNA20		5.0	0.038	1	0.615	
---	------	----	-----	--------------	--	-----	-------	---	-------	--

DESCRIPTION / LEGENDE / LÉGENDE:

 net weight / Nettogewicht / poids net

 volume / Volumen / le volume

 number of packages / Stückzahl der Pakete / nombre de colis

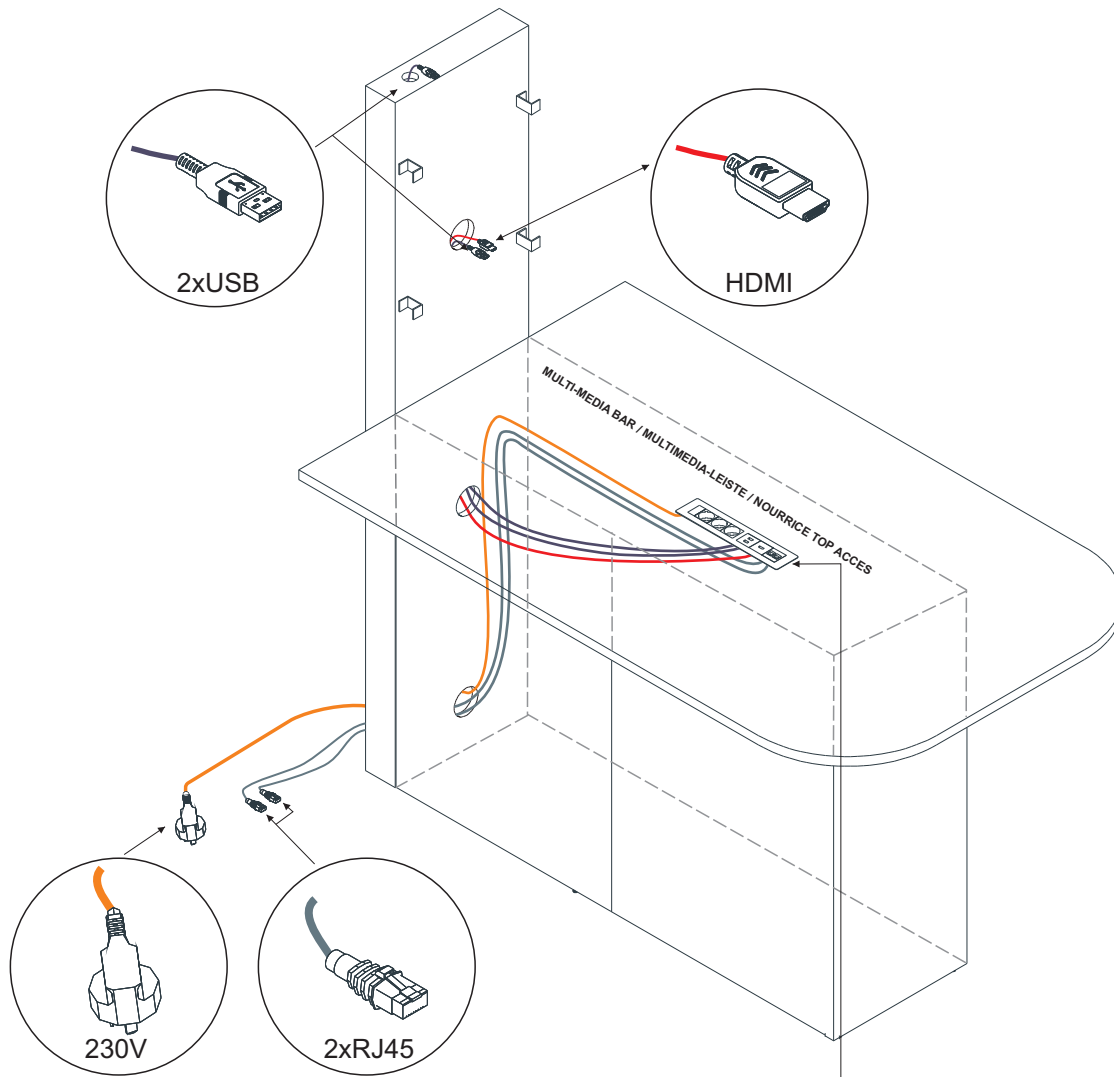

MULTI-MEDIA BAR / MULTIMEDIA-LEISTE / NOURRICE TOP ACCES

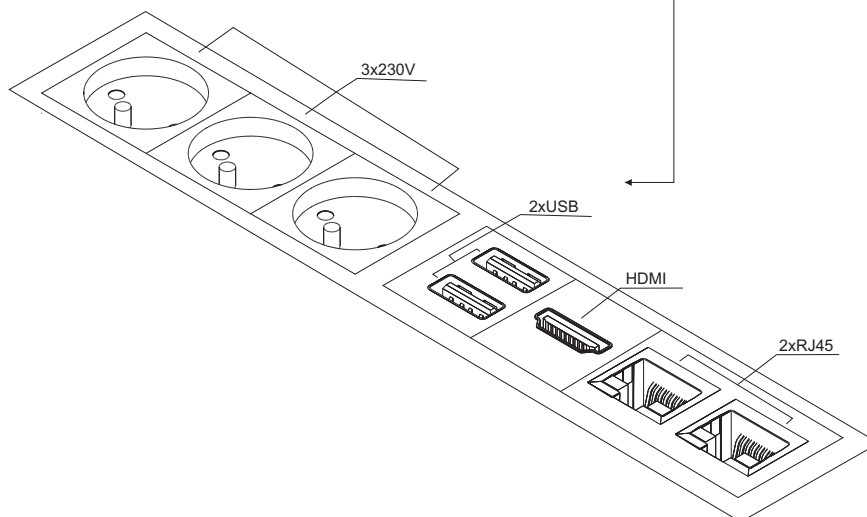



CABLE WIRING ROUTE / VERLEGUNG DER KABEL / ACHEMINEMENT DES

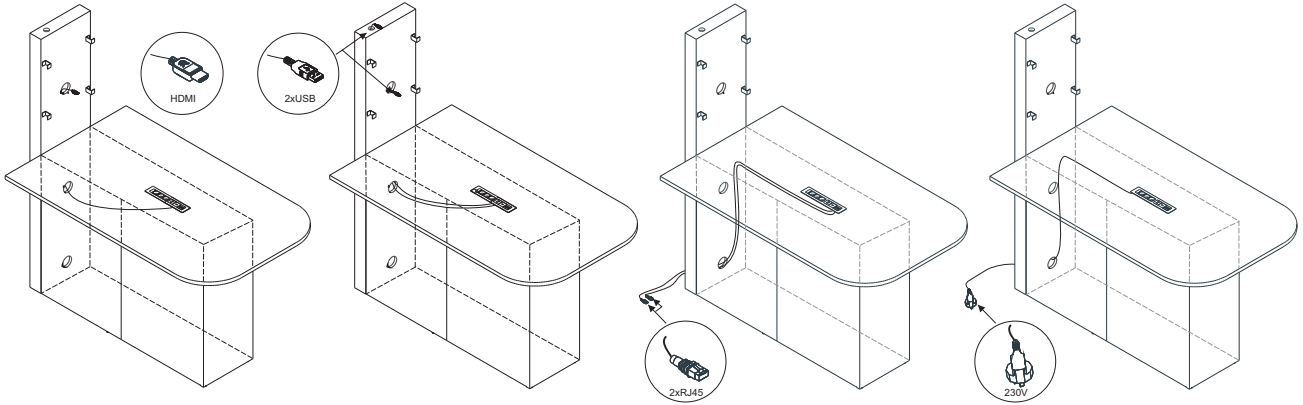

DIMENSIONS / ABMESSUNG / DIMENSIONS

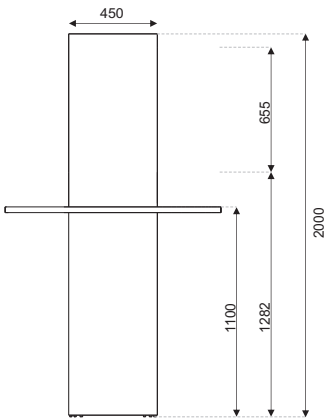

FRONT VIEW

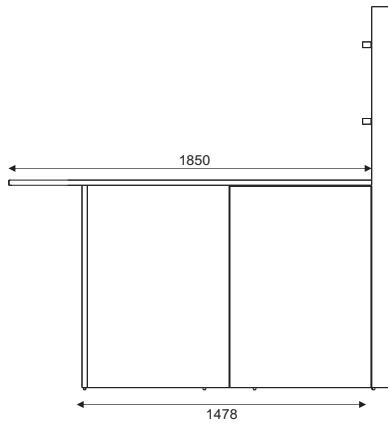

SIDE VIEW

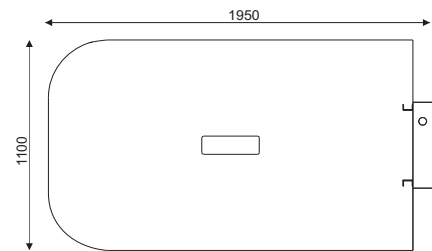

TOP VIEW

FINISHES / FARBEN / FINITIONS



67-WHITE PASTEL
WEIß PASTELL
BLANC PASTEL

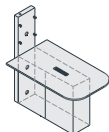



PRODUCT ILLUSTRATION / PRODUKTANSICHT UND SKIZZE / VUE DE PRODUIT	DIMENSIONS / ABMESSUNGEN [mm]			INDEX SYMBOL	PRICE EUR				ECO	COMMENTS / BEMERKUNGEN / REMARQUES
	WIDTH / BREITE / LARGEUR	DEPTH / TIEFE / PROFONDEUR	HEIGHT / HÖHE / HAUTEUR			kg	m3	pcs	EUR	

MULTIMEDIA STATION

	1100	1950	2000	MS01		117.0	0.299	4	12.987	
--	------	------	------	-------------	--	-------	-------	---	--------	--

DESCRIPTION / LEGENDE / LÉGENDE:

net weight / Nettogewicht / poids net

volume / Volumen / le volume

number of packages / Stückzahl der Pakete / nombre de colis